

The syntactic representation of Romance diathesis

Xavier Frías Conde

UNED

xfrias@flog.uned.es

Abstract

It is not quite established a way to represent diathesis in the literature of Generative Grammar. Different attempts have been made to place diathesis as IP, *v*P or some kind of projection with no specific position. Our aim is to provide diathesis with a functional category, diathesis phrase (DIATP), which permits a complete representation of diathetic phenomena in all natural languages. Anyway we will focus on the representation of diathesis in the Romance language, whereas the traditional classifications of Romance diathesis are revised.

Keywords: Diathesis, clitic, Diathesis Phrase, Inflection Phrase, Case assignment, rise, Object Agreement Phrase.

Received: 14.IX.2010 – **Accepted:** 15.XII.2010

Table of Contents

- 1 Foreword
 - 2 The DIATP and the rest of verbal projections
 - 3 Classification of Romance voices
 - 4 Passivization
 - 5 Middle impersonal
 - 6 Middle Ergative
 - 7 Conclusions
- References

1 Foreword

The studies related to diathesis or verbal voice within the Generative Grammar tradition have treated this phenomenon in multiple ways, most of them considering diathesis as a part of the Inflection Phrase (IP) (e.g., see Radford 2009).

Nevertheless, this simplified (rather simplistic) interpretation of the diathesis has a large amount of drawbacks that prevent a serious approach to this essential part of syntax in all languages. That is why we have proposed the introduction of a new functional category, the Diathetic Phrase (DIATP) (Frías 2006), by means of which all the possible implementations of diathesis can be represented in natural languages.¹ Anyway, this paper will just refer to diathesis in Romance languages and its possibilities of representation.

2 The DIATP and the rest of verbal projections

The introduction of DIATP allows us a much better representation of the sentence functional categories. The simplest parsing should include IP (taken as a macrocategory), DIATP, *v*P and VP in the following way:

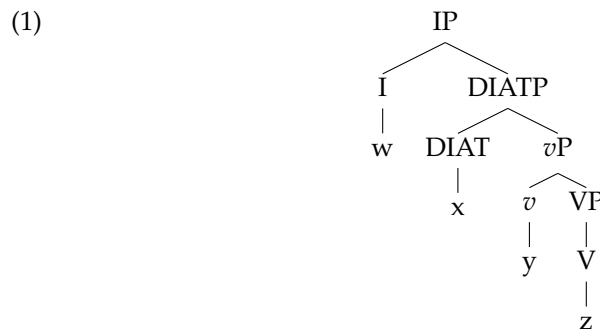

Apart from DIATP, the presence of *v*P is a must to represent passive voice, since the agreement of past participles is compulsory in all Romance languages. This can be seen in the following French example:

- (2) a. La maison a été détruite par le feu. (FR)
'The house was destroyed by fire.'

¹DIATP is our proposal to explain all the diathetical processes in natural languages, as a functional category different from others usually linked to verbs, such as Aspect Phrase, Perfect Phrase, etc. This item has already been used by other colleagues such as Bauçã (2007; 2008–2009).

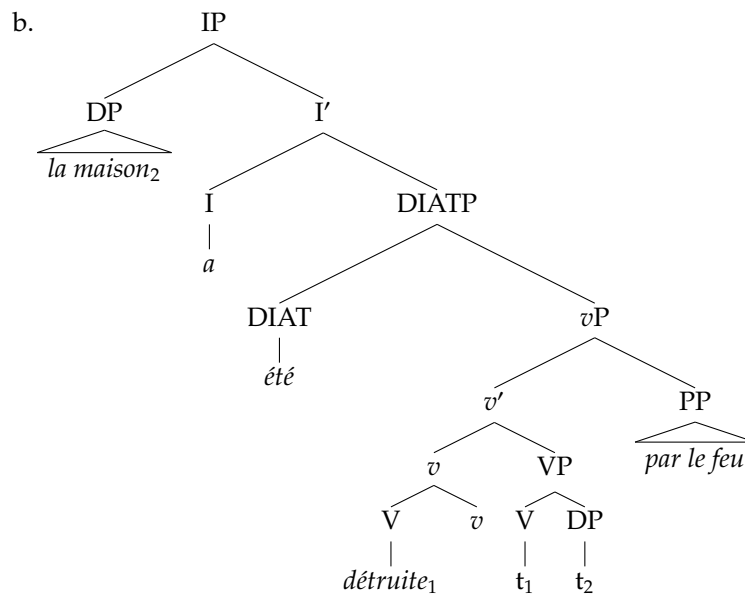

3 Classification of Romance voices

In order to establish the representation of diathesis in the Romance languages, it is necessary to clear up how many types and subtypes of diatheses exist in Romance. We follow the proposal offered in [Frias \(2006\)](#), but with the inclusion of ergativity as a subclass of middle voice (see also [Bauçà 2007](#)).

Romance types can be represented as follows (Spanish examples):

1. Active: *Juan compra pan los jueves.*
2. Middle
 - (a) Impersonal: *Se compra pan los jueves.*
 - (b) Ergative: *El pan se pudre.*
3. Passive: *El pan es comprado los jueves.*

4 Passivization

Passivization is a rather process in which several processes take place. We are not going to refer to the semantic trigger, just to the syntactic consequences of it.

On the one hand, the specifier is dropped, though it may reappear later on as an adjunct (see further), becoming even compulsory item. On the other hand, the complement does not receive accusative case because this feature of the V (the assignation of case to its complement) is prevented by the diathesis.

This is quite an interesting phenomenon that has an important consequence: the transformation of an object into a subject. As a matter of fact, the lack of case makes the complement take the case by default, i.e., nominative, which provokes the movement of that complement into specifier positions having nominative case.

In the Romance languages, the head of DIATP is naturally *être / essere / ser*. As a verb, it may rise into higher positions if necessary (IP, CP). Anyway, DIATP requires a *vP* that attracts *V* in order to assume Agreement, such as it was shown in example (3a).

The rise of the complement into the specifier position is a normal movement in all Romance languages, which causes its interpretation as a subject:

- (3) a. El pan es comprado los jueves. (ES)
 b. Il pane è comprato i giovedì. (IT)
 c. O pão é comprado nas quintas-feiras. (PT)
 d. Le pain est acheté les jeudis. (FR)
 'The bread is bought on Thursdays.'

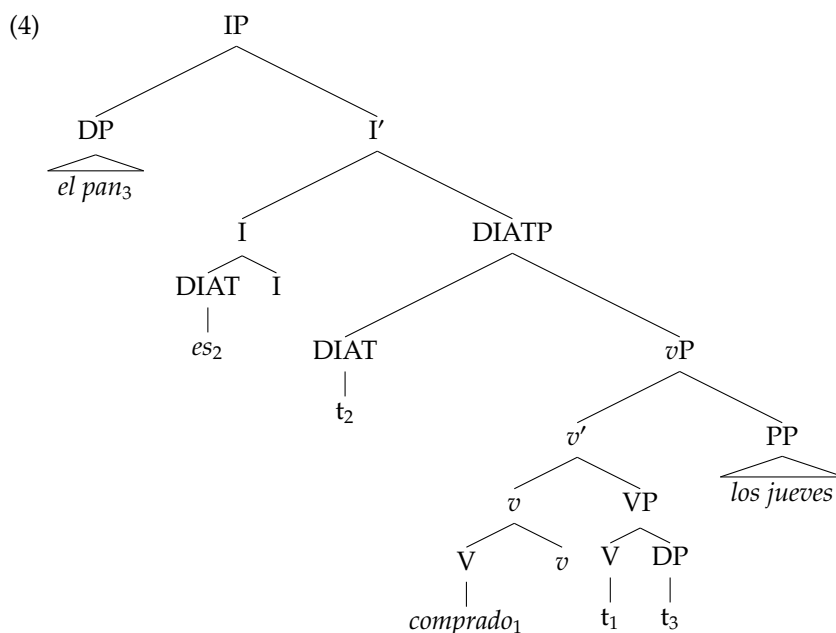

Nevertheless, certain passive constructions require a compulsory agent, which in fact corresponds to the original subject. We will assume that the specifier of *VP* was originally cancelled and that the presence of the agent is a case of compulsory adjunct, i.e., one of these processes by which an adjunct becomes necessary for the well-formedness of the sentence, but it does not eliminate the possibility of a movement from spec-*VP* into adj-*vP*, the position in which we place this compulsory agent.

- (5) a. El libro fue escrito por un autor anónimo. (ES)
'The book was written by an anonymous writer.'

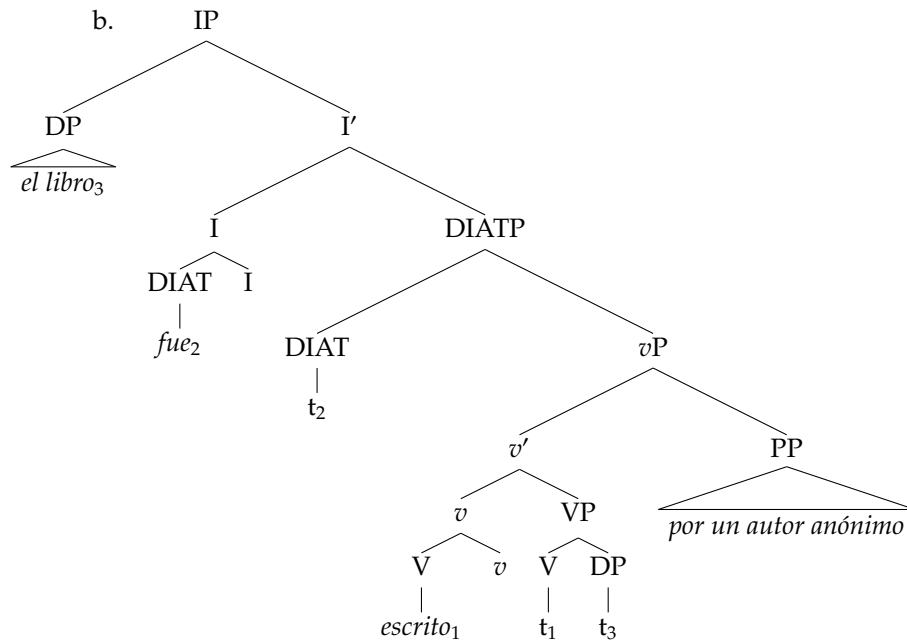

Moreover, in Spanish, Italian and Portuguese the original Object may remain in its original position, but in most cases a topic is required, e.g. (6) and (8). A curious situation occurs in French, where the complement does not rise because an expletive occupies the highest specifier position, e.g. (7) and (9). This can be considered as a more primitive type of passive due to the use of the aforementioned expletive.

- (6) Oggi è aspettato il presidente. (IT)
'The president is waited today.'
- (7) Il a été volé un trésor. (FR)
'A treasure has been stolen.'

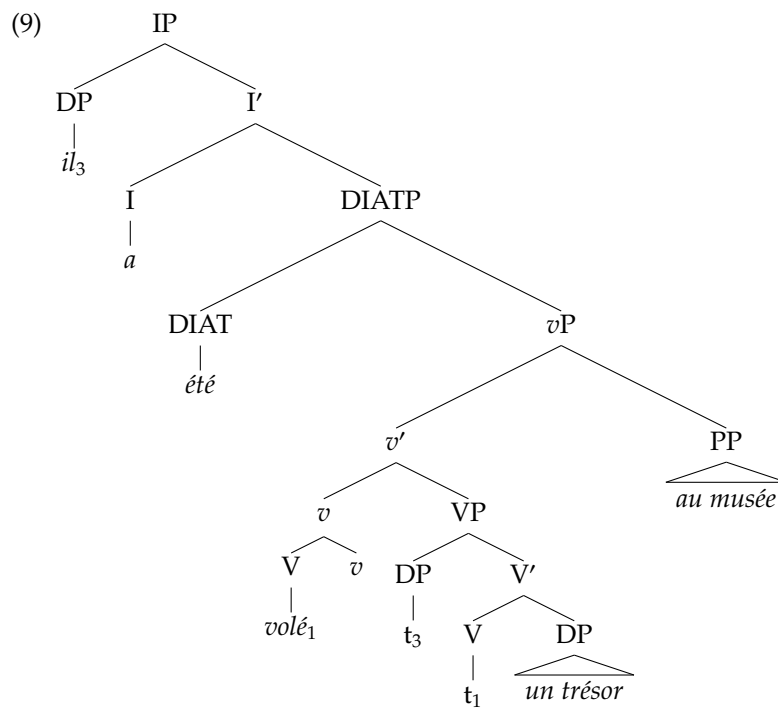
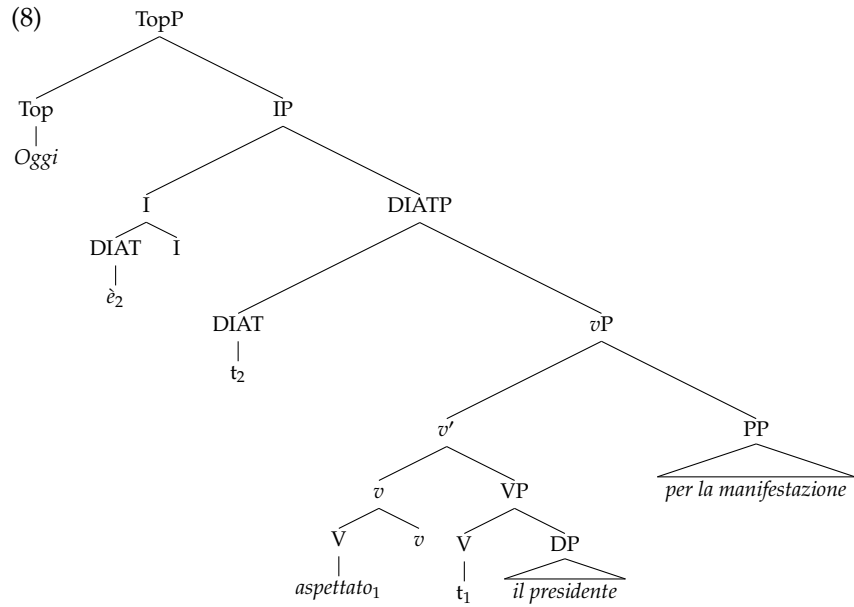

5 Middle impersonal

The inclusion of the middle voice is one of the most innovative proposals in Frías (2006). Middle voice was then considered exclusively as impersonal, but now it is also necessary to add middle ergative, whose syntactic representation is relatively similar.

Middles in almost all Romance languages do not have a verb as a head of their DIATP, but a clitic: *se*.

- (10) a. Se venden melones. (ES)
 b. Si vendono meloni. (IT)
 c. Vendem-se melões. (PT)
 'Watermelons are sold.'

French does not, but we interpret *on* in the same way:

- (11) On vend des melons. (FR)
 'Watermelons are sold.'

The most interesting aspect of this type of constructions is that object agreement phrase (OAGRP) is required. It is the only case in which the Iberian languages (namely Spanish and Portuguese) show object agreement.

In this case, the Predicate does maintain its capacity to assign case (it keeps being Accusative).

- (12) Se tiene **a los chicos en buenas condiciones** → Se **los** tiene. (ES)
 'Children are kept in good conditions.'
- (13) Si passano **buoni film** → Se **ne** passano. (IT)
 'Good films are passed.'

Given the nature of clitics to have a certain freedom within the clause, this *se* can also rise to the highest head position and merge with another head (CP, IP). Diathetic *se* behaves like any other clitic, so its movements are ruled by the same principles as the rest of the clitics. It is important to remember that apart from diathesis, clitics are heads of OAGRP in most Romance languages, such as it can be observed in the following Portuguese example (let's note that the object (complement) is marked as *pro* due to the presence of the clitic):

- (14) a. Têm-no visto muitas vezes. (PT)
 'They have often seen it.'

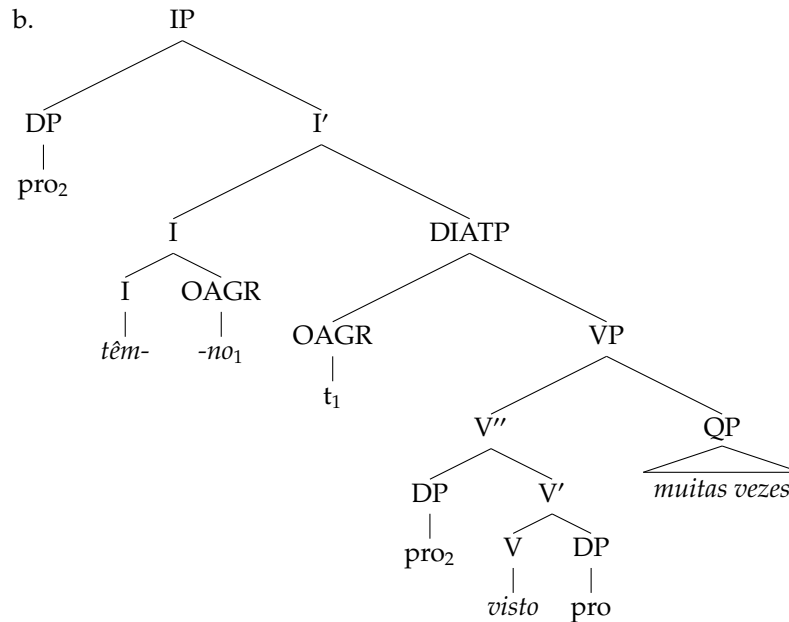

Therefore, the diathetic clitic behaves in the same way as for its capability to merge with the highest head:

- (15) a. *Pode-se comprar pão nessa loja.* (PT)
'It is possible to buy bread in that shop.'

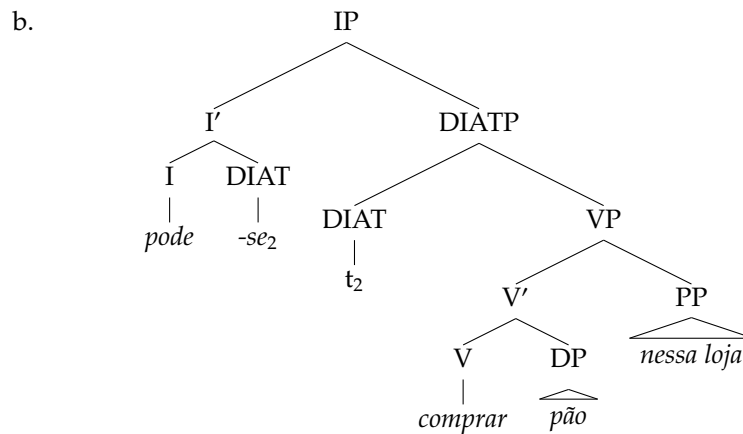

However, when the clitic is merged with the infinitive, it is V that rises up:

- (16) a. *Pode comprar-se pão nessa loja.* (PT)
'It is possible to buy bread in that shop.'

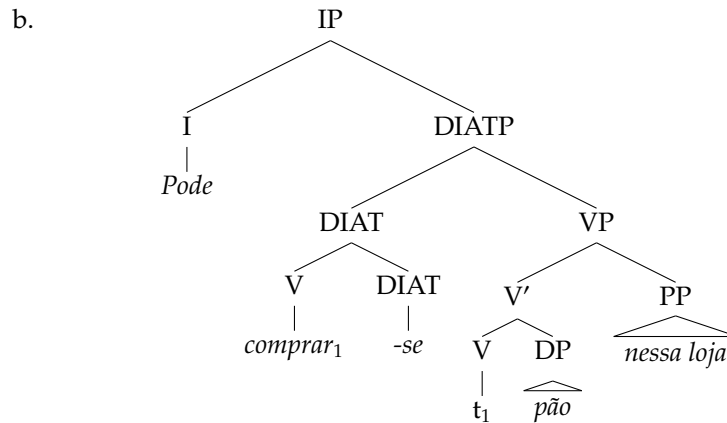

It is quite interesting to check how the previous sentence, corresponding to European Portuguese, shows no movement in Brazilian Portuguese:

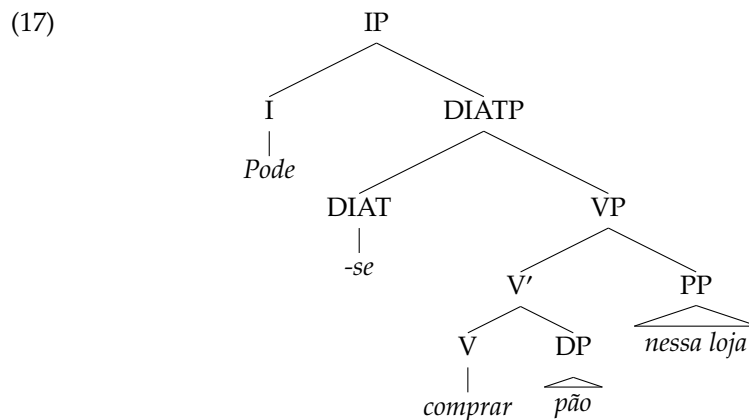

6 Middle Ergative

Middle ergative constructions are half-way between middle impersonal and passive. From a structural point of view they resemble middle impersonal constructions due to the use of a clitic as head of the DIATP, but the deepest semantic changes make them resemble passive structures because of the lack of the first valence and the role of the DIAT, which prevents the assignation of case (see Frías & López Silva 2001).

In Romance languages, ergative constructions tend to be confused with reflexive ones, but from a semantic point of view that turns out impossible. Observe these Spanish examples, where the first one is reflexive and the second one is ergative:

- (18) El niño se lava (→ a sí mismo). (ES)
'The child washes himself.'

- (19) El coche se lava bien (\rightarrow *a sí mismo). (ES)
 'The car washes easily / The car turns out easy to wash.'

Observe how the ADV *bien* is necessary in the second example for the well-formedness of the sentence. Many ergative constructions require something that has been already mentioned previously: an original adjunct that becomes obligatory.

The analysis of both sentences is respectively:

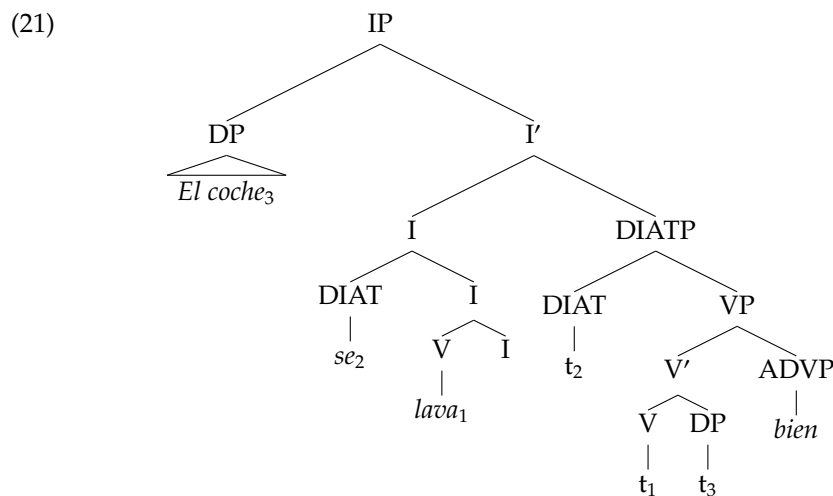
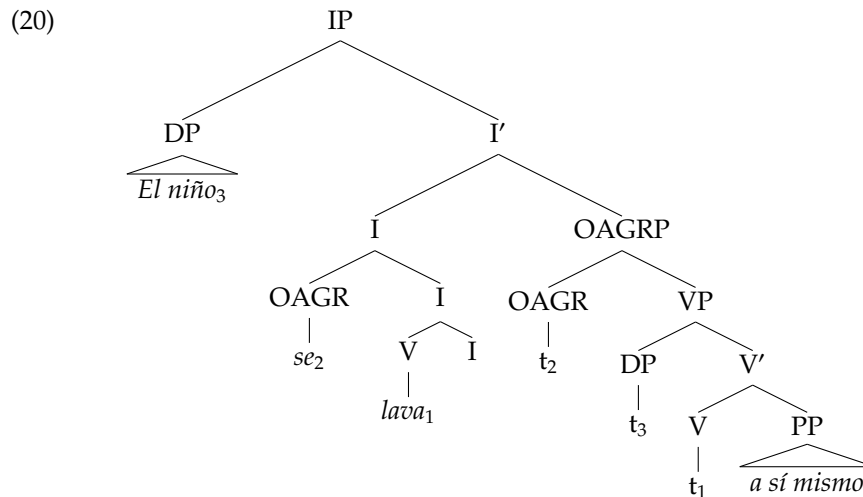

It is very to observe the parallelism between both sentences. The clitic *se* works in a very similar way in both cases, despite in the first one is the head of the OAGRP and in the second one is the head of DIATP, but given that in both cases it is a clitic, there are reasons to believe that from a diachronic point of view both structures derive from a common one.

Within the Romance group, it is quite usual that Galician shows a covert clitic as the head of the DIATP. Observe the following two examples where Galician is compared with Spanish:

- (22) a. El barco se hundió. (ES)
'The ship sank.'

b.

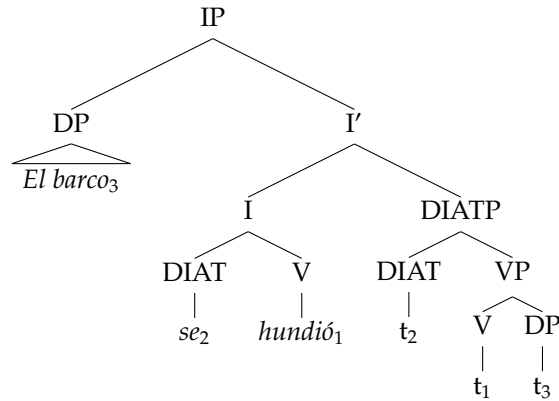

- (23) a. O barco afundiu. (GL)
'The ship sank.'

b.

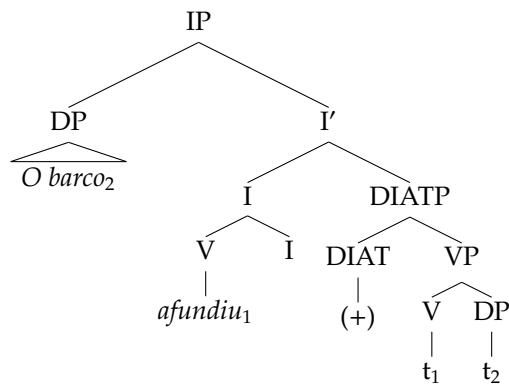

On the other hand, word order in this case is crucial, since it allows speaker to distinguish between ergative and transitive clauses with a null-subject. In ergative clauses the original complement, now the subject, has to move up, while in transitive clauses the complement—which maintains its accusative case—remains in site:

- (24) a. *pro* afundiu o barco. (GL)
'[Someone] sank the ship.'

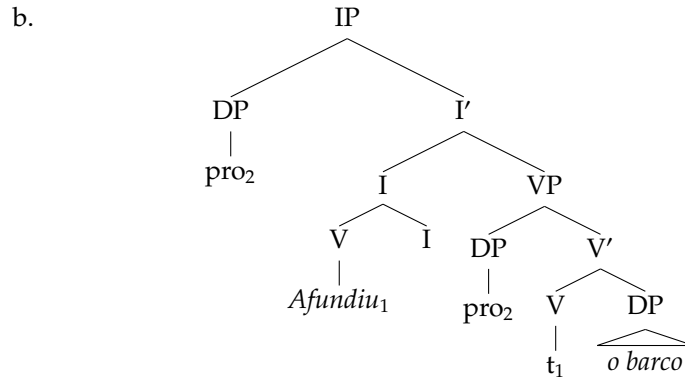

7 Conclusions

We have not offered a complete view of diathesis in the Romance languages; it has just been a quick overview, because our aim was to introduce DIATP as a very useful tool to understand the behaviour of this verbal feature.

The only point we want to highlight is the duplicity of heads of DIATP's, where on the one hand it is either a verb (in passive constructions) or a clitic (in middle constructions). French constructions with *on* can be considered a variation of these constructions, since French —as well as other Romance languages, mainly Gallo-Italian ones— do know nominative clitics. We have not offered any previous analysis of these sentences, but they can be interpreted like this:

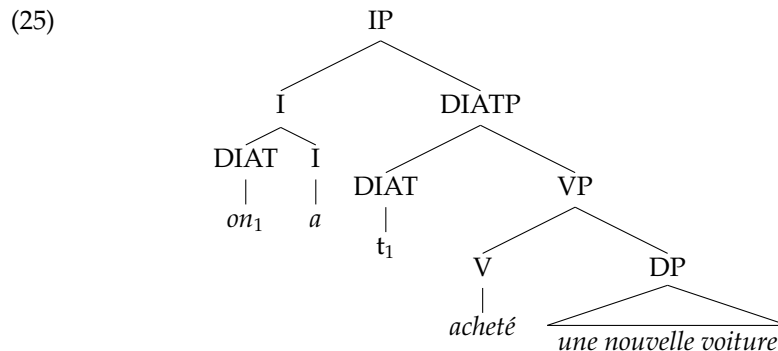

Moreover in French the diathesis does not prevent the V to assign accusative case. The comparison among different languages throws light upon the different behaviours and processes involved in the diathesis. Where Romance language present a weak DIAT for impersonal middle voice that maintains case assignation, Slavonic languages present a strong one —whose head is also a clitic—, so that the complement gets no case from the verb; this phenomenon is quite interesting, since Slavonic languages tend to prevent case assignation in all circumstances, while in Romance languages case assignation is maintained

at least in one case (impersonal middle voice). This is a Czech example of impersonal middle voice where the complement has nominative case:

- (26) a. Ovoce se prodává na náměstí. (CS)
'Fruit is on sale at the square.'

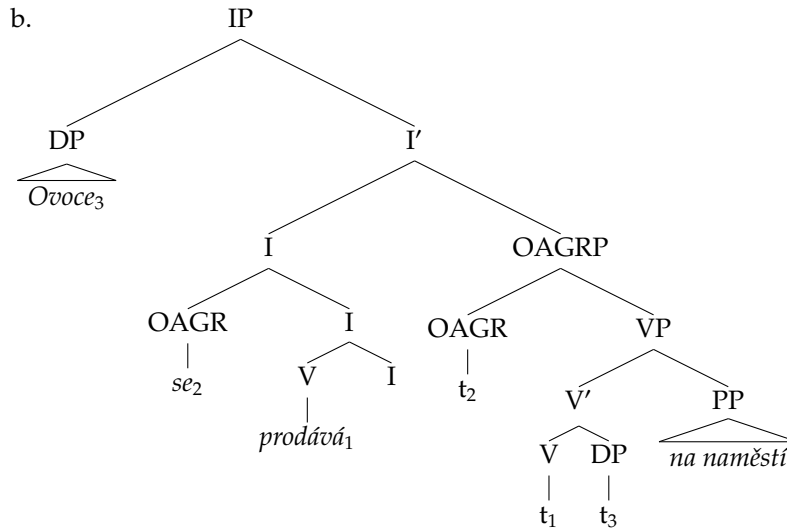

Therefore this is just the beginning of a new way to interpret diathesis. The diversity and plurality of Romance diathesis has just been outlined but it will require many deeper and more detailed studies.

References

- BAUÇÀ I SASTRE, Andreu (2007): «La diàtesi: Concepte, formes i usos en les llengües romàniques.» *Ianua. Revista Philologica Romanica* 7: 5–13. URL: <<http://www.romaniaminor.net/ianua/Ianua07/01.pdf>>.
- (2008–2009): «Diàtesi i subjecte afectat: El cas de l'ús auxiliar de <ser> en les llengües romàniques.» *Revista de Llengües y Literatures Catalana, Gallega y Vasca* 14: 175–192. URL: <<http://e-spacio.uned.es/fez/view.php?id=bibliuned:Llcv-2008-2009-14-3090>>.
- FRÍAS CONDE, Xavier (2006): «La voix moyenne dans les langues romanes.» *Revista de Filología Románica* 23: 215–228. URL: <<http://revistas.ucm.es/fll/0212999x/articulos/RFRM0606110215A.PDF>>.
- FRÍAS CONDE, Xavier; LÓPEZ SILVA, Xosé Antonio (2001): «As construcións con *se* en galego: O problema da súa natureza e clasificación.» In: Xosé Luís REGUEIRA; Alexandre VEIGA [ed.]: *Da gramática ó dicionario: Estudos de lingüística galega*. (Verba, Anuario Galego de Filoloxía, Anexo 49). Santiago de Compostela: Universidade de Santiago de Compostela, 127–142.

RADFORD, Andrew (2009): *Analysing English sentences: A minimalist approach*.
Cambridge; New York: Cambridge University Press.

Xavier Frías Conde
UNED (Universidad Nacional de Educación a Distancia)
Facultad de Filología
Paseo Senda del Rey, 7
E-28040 Madrid
Spain