

# Directionality and the Production of Ungrammatical Sentences\*

ASH ASUDEH

University of Oxford & Carleton University  
ash.asudeh@ling-phil.ox.ac.uk

It is a puzzling fact that English speakers produce resumptive pronouns under certain circumstances, yet reject sentences containing resumptives as ungrammatical. This paper reviews a language production model that attempts to solve this problem through prioritization of local well-formedness over global well-formedness and, more specifically, considers the model's implications for directionality in grammar. In particular, English resumptive in islands imply that the unbounded dependencies in grammar are filler-driven, featurally defined at the top of the dependency, and that islands are identifiable by the grammar from outside the island, in a top-down fashion. Lexical-Functional Grammar provides the formal framework for incrementality in the production model, which is based on monotonic information growth in LFG grammars. LFG also provides a formal, 'outside-in' theory of unbounded dependencies that treats them as filler-driven and allows island barriers to be identified from outside of the island, rather than from the inside.

## 1. Introduction

The language faculty is a knowledge system that characterizes linguistic competence. Derivations in syntax, as laid out most influentially in the work of Chomsky, are understood as a formal mechanism in the system that characterizes this knowledge; i.e. derivations are a component in the specification of the set of well-formed expressions in a language. As part of linguistic competence, derivations are not necessarily understood as specifying the order of steps in language processing, which is an aspect of linguistic performance. Students of transformational grammar are discouraged from interpreting derivational syntax as embodying claims about the order or nature of processing. In this context, the issue of whether linguistic structures in the competence system are computed top-down vs. bottom-up or left-to-right vs. right-to-left is a purely algorithmic aspect of how the competence system works. For non-derivational, constraint-based theories of syntax, such as Head-Driven Phrase Structure Grammar (HPSG; Pollard and Sag 1987, 1994, Ginzburg and Sag 2000) and Lexical-Functional Grammar (LFG; Kaplan and Bresnan 1982, Bresnan 2001, Dalrymple 2001), the question of directionality seems yet more immaterial. Linguistic structures in these theories must satisfy a set of unordered constraints, so the result is always equivalent, no matter the algorithmic starting point for solving the constraints.

Nevertheless, the competence system is embedded in a processing system and directionality is an important part of the latter system (Jackendoff 2007). Parsing/understanding works from form to meaning and production/generation from meaning to form. Moreover, it is a standard view in psycholinguistics that parsing and production are incremental. Increasingly, however, incrementality has become a locus of explanation of facts of the competence system itself. For example, Phillips (2003) proposes the "Incrementality Hypothesis", which states that "Sentence structures are built incrementally from left to right",

---

\* I would like to thank the following people for helpful comments, suggestions and discussion: Emily Bender, Joan Bresnan, Mary Dalrymple, Nicolas Guilliot, Philip Hofmeister, Florian Jaeger, Peter Sells, Neal Snider, Mike Tanenhaus, and audiences at Carleton University, the Hebrew University of Jerusalem, the Linguistics Association of Great Britain, the University of Canterbury, and the University of Rochester. Any remaining errors are my own. I would also like to thank Cristiano Chesi for patiently shepherding this paper. This research was supported by an Early Researcher Award from the Ontario Ministry of Research and Innovation and NSERC Discovery Grant #371969.

as part of an explanation of conflicts in tests of syntactic constituency. Incrementality is a cornerstone of constraint-based syntactic theories, where it is an automatic consequence of the formal system. Incrementality is formally captured as monotonic information growth: generally, as the set of constraints that describe the linguistic structure grows larger, so does the structure that satisfies the constraints (Bresnan 2001: chapter 5).<sup>1</sup>

Lexical-Functional Grammar provides a particularly good platform for investigating issues of directionality and incrementality. The current LFG theory of unbounded dependencies is based on *functional uncertainty* over paths in LFG's f(unctional)-structures (Kaplan and Zaenen 1989, Dalrymple 2001). Functional uncertainty is based on a characterization of functional application using regular expressions. There are two kinds of functional uncertainty: outside-in and inside-out. Outside-in functional uncertainty checks a path through an f-structure starting at an outer f-structure and working its way in. Outside-in functional uncertainty therefore works 'left-to-right' on an f-structure. Inside-out functional uncertainty checks a path through an f-structure starting at an inner f-structure and working its way out. Inside-out functional uncertainty therefore works 'right-to-left' on an f-structure.

I will argue that outside-in functional uncertainty together with a natural account of local well-formedness of fragments yields an explanation of otherwise puzzling data to do with resumptive uses of pronouns and other nominals in English, as in (1).

- (1) \*Mary knows the man who Thora saw him.

Most dialects of English do not have grammars that license resumptives (Chao and Sells 1983, Sells 1984), so sentences like (1) are generally judged as ill-formed. Sells (1984) introduced the term "intrusive pronoun" for these ungrammatical resumptive-like pronouns.

The puzzle is the following:

- (2) **Intrusive Pronoun Puzzle:**

Native speakers reject intrusive pronouns as ungrammatical, yet produce them.

This behaviour is distinct from other superficially similar cases, such as center embedding (Chomsky and Miller 1963). In these other cases, a speaker rejects a form as ungrammatical but also would not be expected to produce it. The usual explanation of center embedding and other relevant phenomena is that a speaker fails to parse or produce, due to performance reasons, a sentence that is underlyingly grammatical. In Asudeh (2011a, 2012), I have proposed very much the opposite sort of explanation for intrusive pronouns: what speakers are doing with intrusive pronouns is producing a form that is underlyingly *ungrammatical*. The form is produced due to the processor's prioritization of local well-formedness over global well-formedness.

In this paper, I consider the theoretical implications of this proposal in light of the phenomenon of intrusive pronouns in islands, as in (3).

- (3) John would like to meet the linguist who Peter knows a psychologist that works with her.

If the explanation for the Intrusive Pronoun Puzzle (IPP) is that local well-formedness is prioritized over global well-formedness, then the explanation of intrusives in islands can be assimilated to the explanation of the IPP only if the island structure itself is locally well-formed. The island cannot be locally well-formed in a theory that defines islands from the inside-out, or in terms of some kind of notion of bounding node or barrier or phase that blocks upward movement of a constituent that originates in a position within

<sup>1</sup> This statement is qualified for two reasons. First, mechanisms have been introduced that slightly relax the monotonicity requirement on a per constraint basis. The mechanism in HPSG is defaults (Lascarides and Copestake 1999). The mechanism in LFG is restriction (Kaplan and Wedekind 1993). Restriction is not strictly non-monotonic, because a subsumption relation is preserved between relevant structures, but addition of a constraint containing the restriction operator does not result in structural growth. Second, as will become clearer below, there are constraints in LFG that check structures but which do not themselves add information. Addition of these constraints to the set of constraints describing a structure does not result in structural growth, but a system containing the checking constraints but not restriction is strictly monotonic, because addition of constraints in the absence of restriction never results in a less specific structure. Moreover, if we construe monotonicity as a property of the set of constraints itself, rather than of the structures themselves, then even the system with restriction is strictly monotonic (Ron Kaplan, p.c.), because the equation containing the restriction operator is still an equation that is added to the set of constraints such that the set of constraints grows; similarly, the checking constraints also enlarge the set of constraints.

the island (Chomsky 1973, 1986, 2001), or in a theory that prevents island structures from being built at all (cf. Creswell 2002 on the problem of resumption for islands in Tree Adjoining Grammar). Therefore, it is reasonable to conclude based on intrusive pronoun data that, if a theory seeks to capture the relevant sorts of islands in the competence grammar, island constraints must be definable from outside the island, such that the island itself is *locally* well-formed. If island constraints are defined from outside the island, this in turn favours a theory of unbounded dependencies that involves top-down search in the grammar for the integration site of the constituent at the top of the unbounded dependency (e.g., a *wh*-pronoun). Thus, the explanation of the IPP in Asudeh (2011a, 2012) has a consequence with respect to directionality: the integration of unbounded dependencies in grammatical structure must be filler-driven not gap-driven.

## 2. The Problem

The fact that English speakers produce intrusive pronouns and other nominals in resumptive contexts has been known for quite some time. Kroch (1981: 129) discusses examples like the following, which contains an intrusive epithet:

- (4) There was one prisoner that we didn't understand why the guy was even in jail.

Kroch (1981) proposes an incremental model of speech production that crucially generates a filler before planning of the sentence has been completed. As production proceeds, the system enters a situation where the intended base position of the filler-gap dependency is in an island or would violate the *that*-trace filter/Empty Category Principle (ECP). An NP is inserted to avoid the violation, a kind of transderivational repair strategy. In short, Kroch's proposal is that some nominal, typically a pronoun (but not necessarily, because of examples like the one above), is inserted to avoid a grammatical violation due to poor planning.

In subsequent work, Prince (1990) showed, based on a collection of naturally occurring utterances, that the insertion of intrusive pronouns is quite pervasive. Examples such as the following illustrate that intrusive pronouns occur even in situations where a gap would actually be well-formed (Prince 1990: (4c) & (15d)):

- (5) I have a friend who she does all the platters.

- (6) You get a rack that the bike will sit on it.

Examples like these cast serious doubt on the viability of intrusives as a repair strategy, because they occur in the absence of a structure needing repair, since the relative clause without the pronoun is perfectly well-formed.

In fact, Prince presented examples in which the intrusive nominal is not a pronoun or even an epithet. She showed that any kind of nominal that can be anaphoric in discourse can serve the role of an intrusive pronoun (Prince 1990: (34a–d)):

- (7) I had a handout and notes from her talk that that was lost too.

- (8) He's got this lifelong friend who he takes money from the parish to give to this lifelong friend.

- (9) I have a manager, Joe Scandolo, who we've been together over twenty years.

- (10) You assigned me to a paper which I don't know anything about the subject.

These data support Prince's contention that intrusive pronouns are not bound variable pronouns, unlike grammaticized resumptives, thus also supporting Sells's original treatment of intrusive pronouns as discourse pronouns (Sells 1984).

Creswell (2002) rejects Kroch's proposal that it is avoidance of ungrammaticality due to poor planning that leads to insertion of intrusive nominals. She contends that the grammar generates intrusive nominals in islands, based on theoretical considerations of Tree Adjoining Grammar (TAG; Joshi et al. 1975). Creswell observes that the theory of Frank (2002), which embeds TAG within the Minimalist Program (Chomsky 1995), does not permit generation of island-violating trees. She also notes that TAG-based models of incremental production (Ferreira 2000, Frank and Badecker 2001) do not permit Kroch's solution, because they assume that the processing system uses only sub-trees licensed by the grammar to build larger trees and there are no such sub-trees in the case of island violations. Therefore, based on Creswell's TAG assumptions, the underlying structure that the speaker would have to remedy, according to Kroch's (1981) theory, is unavailable. Creswell (2002) argues that in fact the grammars of English speakers must independently have the resources required to form island structures containing intrusive

nominals. In other words, she argues that at least certain intrusive nominals are underlyingly grammatical in English.

Ferreira and Swets tested the production of intrusive pronouns in *wh*-islands by native speakers of English (Swets and Ferreira 2003, Ferreira and Swets 2005). They used a self-paced experimental task in which subjects were required to complete (in full sentences) partial descriptions that were presented with a picture array. The target sentences were sentences such as:

(11) This is a donkey that I don't know where it lives.

I will henceforth call this target sentence type "island-intrusive sentences" or "island-intrusives".

Two control targets were also elicited. One controlled for surface length:

(12) This is a donkey that doesn't know where it lives.

The other controlled for length of the *wh*-dependency without an island violation:

(13) This is a donkey that I didn't say lives in Brazil.

Ferreira and Swets conducted two versions of the production experiment. In the first experiment, subjects were allowed as much time as they wanted to plan the utterance before speaking. In the second experiment, a deadline procedure (Ferreira and Swets 2002) was used to pressure subjects to begin speaking quickly. If intrusive pronouns in *wh*-islands are a result of lack of planning, as per Kroch (1981), then speakers in the no-deadline condition should plan the utterance to avoid both the island violation and the intrusive pronoun. For example, a participant could construct the following sentence instead of (11):

(14) This is a donkey and I don't know where it lives.

In contrast, in the deadline condition, speakers should not have time to plan an utterance that avoids an intrusive pronoun. Thus, the expectation is that, if intrusive pronouns are produced due to poor planning, there should be greater occurrence of intrusives in the deadline condition than in the no-deadline condition.

Instead, experimental participants overwhelmingly produced island violations like (11) in both conditions. In the no-deadline experiment, subjects could take as much time as they needed to plan their utterance before speaking and they did use this time, taking on average more than 2200 ms to begin. Nevertheless, 67% of the sentences produced for the target condition involved an island containing an intrusive (Ferreira and Swets 2005: 274). In short, subjects did not use the extra time in the no-deadline experiment to plan an utterance that avoids an intrusive pronoun. In fact, the deadline experiment had a *lower* proportion, 56%, of island-intrusive sentences. The deadline experiment did result in a greater number of alternative well-formed sentences that were not targets, like the coordination *This is a donkey and I don't know where it lives* or the left dislocation *This donkey I don't know where it lives*. Such alternatives were produced more often in the deadline experiment than in the no-deadline experiment, which leads Ferreira and Swets to conclude that island-intrusives are not mistakes. Such sentences are valid productions of the processing system (Ferreira and Swets 2005: 274).

Thus, one of Ferreira and Swets's (2005: 274) main conclusions is that island-intrusives are "intentionally produced"; i.e. speakers plan to produce island-intrusive sentences. Swets and Ferreira (2003) outline a Tree Adjoining Grammar solution for generating the island-intrusive sentences and speculate that the reason that the structures are rejected despite being produced is that "the production and comprehension systems may set different parameters for accepting these structures." The proposal is that the elementary trees required for producing the island-intrusives are part of the grammar and that the grammar treats island-intrusive sentences as well-formed for production, but not for comprehension. Like Creswell (2002), Swets and Ferreira (2003) contend that the island structures containing intrusive nominals are in fact underlyingly grammatical and they provide experimental evidence that they are not the result of poor planning. In their subsequent work, Ferreira and Swets (2005) no longer make the claim that the island structures are grammatical, and conclude only that "the production system has a modular architecture, because the message level system does not consider grammatical constraints when it creates a message level representation for the grammatical encoder" (Ferreira and Swets 2005: 276).

The claim that intrusive nominals in islands are grammatical is problematic. There are experimental studies that support the long-standing theoretical claim that the grammar of English does not license resumptive pronouns. Ferreira and Swets themselves ran two grammaticality judgment experiments. The first experiment was in the visual modality and the second in the auditory. Participants were asked to rate sentences like the island-intrusive (11) and the structural control (12) on a forced scale of 1 (perfect) to

5 (awful) based on whether the sentences were acceptable in English. In the visual presentation, island-intrusive sentences were rated at an average of 3.3, but control sentences rated at an average of 1.9. This significant difference was confirmed by the auditory presentation, where the average ratings were 3.0 (intrusives) and 1.7 (control), also a significant difference. These findings are all the more striking, since the participants, who rate the island-intrusive sentences as quite bad in comprehension, are from the very same population that reliably produced them.

These findings reflect other findings in the experimental literature. McDaniel and Cowart (1999) and Alexopoulou and Keller (2002, 2007) studied intrusive pronouns in islands using Magnitude Estimation (Stevens 1956, 1975, Bard et al. 1996). ME allows subjects to construct their own scale instead of using a forced scale. These studies found that an intrusive pronoun does not improve the grammaticality of islands. Alexopoulou and Keller (2002, 2007) demonstrate that, even at two levels of embedding, an intrusive does not improve the grammaticality of weak or even strong islands. These results have recently been replicated for complex noun phrase islands and relative clause islands by Xiang et al. (2008). Another recent study has shown once again that resumptives in English do not render a sentence more acceptable than a version with a gap, but that the acceptability of intrusive pronouns does improve in contexts that are harder to process (Hofmeister and Norcliffe 2013).

This brings us back to the 'Intrusive Pronoun Puzzle', which I will henceforth call the 'Intrusive Nominal Puzzle' in light of the observations, discussed above, by Kroch (1981) and Prince (1990) that the intrusive is not necessarily a pronoun:

(15) **Intrusive Nominal Puzzle (INP):**

Native speakers of English reject intrusive nominals as ungrammatical. Even in islands, intrusive nominals are as unacceptable as gaps.

Nevertheless, speakers produce intrusive nominals, even when they have time to plan alternative utterances without intrusives.

The proposal that there is a distinction between production and comprehension of intrusives is not appealing, because it posits distinct grammars for production and comprehension. This is not only unpar-simonious, but also empirically and theoretically problematic, since it creates a much harder explanatory problem: that of explaining why the two systems are generally so congruent. Furthermore, other cases of underlying grammaticality, despite unacceptability, such as center embedding, do not similarly separate production and comprehension. In centre embedding, the unacceptable-but-grammatical form is also not produced, due to the same underlying performance restrictions that render it unacceptable in comprehension.

In what follows, I begin by reviewing the solution to the INP presented in Asudeh (2011a, 2012). The explanation takes facts at face value: intrusive nominal sentences in English are in fact underlyingly ungrammatical, but the production system prioritizes local well-formedness over global well-formedness in such a way that the sentences can nonetheless be produced. The solution is based on monotonic structure-building in LFG and has implications for directionality. The case of intrusives in islands in particular lends support to capturing islands from the outside in, since this allows the island structure to be produced, given the incrementality of production and the prioritization of local well-formedness. I first turn to an overview of some relevant concepts of LFG, before returning to the production model in section 4.

### 3. Lexical-Functional Grammar

#### 3.1. General Background

Lexical-Functional Grammar is a lexicalist, constraint-based theory of grammar (Kaplan and Bresnan 1982, Bresnan 2001, Dalrymple 2001). Lexical items constitute key loci for grammatical information and for cross-linguistic variation. LFG posits two syntactic representations: c(onstituent)-structure and f(unctional)-structure. C-structure represents word order, dominance and constituency, as modelled by a standard (non-tangled) tree; see the left side of (16). F-structure models more abstract aspects of syntax, such as predication and grammatical functions, null pronominals, local and unbounded dependencies, etc. F-structure is modelled as a feature structure; see the right side of (16). The  $\phi$  correspondence function maps elements of c-structure to elements of f-structure, as exemplified in (16).

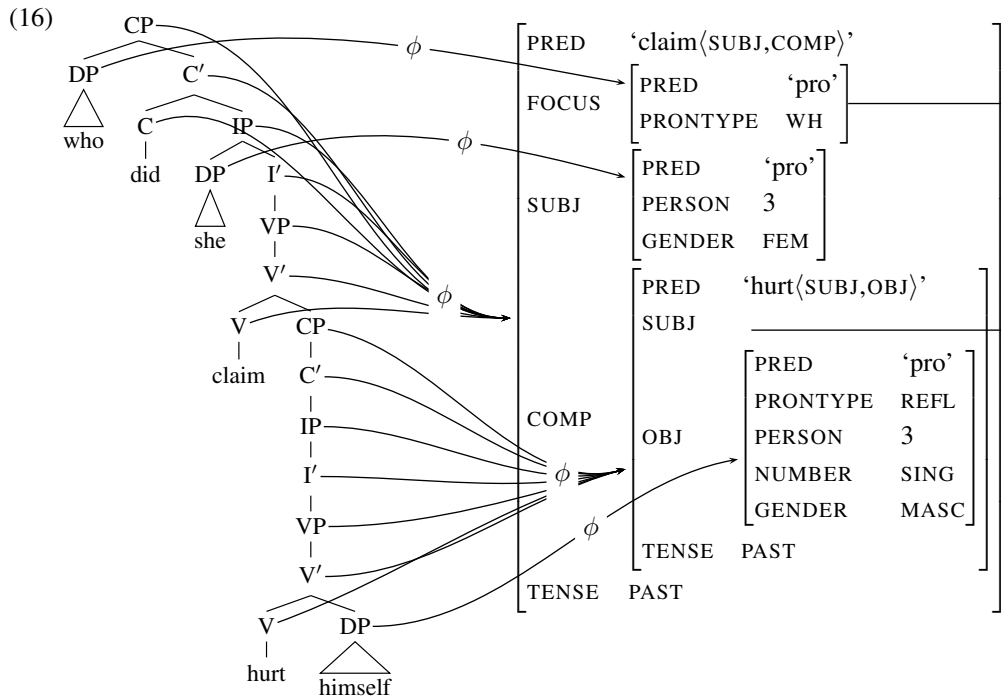

C-structure and f-structure have been understood for some time as just two components of a larger grammatical architecture, the Correspondence Architecture (Kaplan 1987, 1989, Halvorsen and Kaplan 1988, Asudeh 2004, 2006, Asudeh and Toivonen 2009, Asudeh 2012), which divides the form-meaning mapping into a series of simultaneously-present, discrete modules, each of which represents distinct linguistic information. One recent version of the architecture is shown in Figure 1. The various correspondence functions thus allow a single lexical entry to simultaneously specify constraints about a variety of grammatical information. The correspondence functions are functions in the mathematical sense and can therefore be composed (Kaplan 1987). For example, the original  $\phi$  correspondence function between c-structure and f-structure is the composition of the  $\lambda$  and  $\alpha$  functions in Figure 1 (Butt et al. 1997).

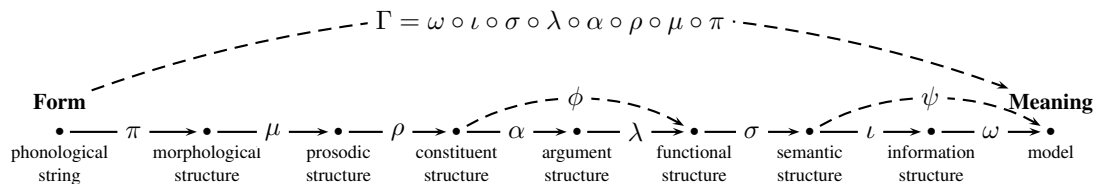

Figure 1: The Correspondence Architecture, pipeline version (Asudeh 2012)

LFG distinguishes the formal structures themselves from constraints on structures, which are structural descriptions that well-formed structures must satisfy. The formal structures of c-structure are phrase structure trees. Constraints on c-structures are phrase structure rules, where the right hand side of the rule is a regular expression (Kleene 1956). C-structure constraints in LFG thus support optionality, disjunction, conjunction, and unbounded repetition. The formal structures of f-structure are feature structures (a.k.a. attribute-value matrices). An f-structure is a finite set of attribute-value pairs. An attribute is a symbol and its value is either 1) a symbol, 2) a semantic form (a possibly complex symbol in single quotes), 3) a set, or 4) an f-structure. Constraints on f-structures are stated in a quantifier-free theory of equality. For example, the defining equation in (17) states that the f-structure  $f$  has an attribute CASE whose value is ACCUSATIVE.

$$(17) \quad (f \text{ CASE}) = \text{ACCUSATIVE}$$

Equation (17) is a *defining equation*, which defines the f-structure as having the attribute-value pair. An alternative sort of equation is a *constraining equation* (notated with a subscript  $c$  on the equality:  $=_c$ ), which checks that the minimal f-structure satisfying all defining equations has the attribute-value pair, but which does not itself result in the f-structure having the information. Other varieties of constraints are

negative equations, existential constraints and negative existential constraints. A comprehensive overview of LFG’s syntactic structures and constraints on these structures can be found in Dalrymple (2001: 7–176). For briefer overviews, see Dalrymple (2006) or Asudeh and Toivonen (2009).

### 3.2. Unbounded Dependencies

The original LFG theory of unbounded dependencies depended on special meta-variables in c-structure (Kaplan and Bresnan 1982: 231–263). The phrase-structural approach was abandoned in light of evidence and argument that unbounded dependencies are subject to functional constraints and should therefore be captured at f-structure (Kaplan and Zaenen 1989). The formal mechanism that allows this is *functional uncertainty* over grammatical functions in constraints on f-structures. The constraint language is a regular language, so the uncertainty is formally captured through regular operations, such as disjunction, negation, and the Kleene operators.

F-structure constraints for filler-gap dependencies in the Kaplan and Zaenen (1989) theory have the following general form:

$$(18) \quad (\uparrow \mathbf{Top}) = (\uparrow \mathbf{Body Base})$$

The top of the dependency, schematized as **Top**, is normally taken to be one of the discourse functions TOPIC or FOCUS (Kaplan and Zaenen 1989, King 1995, Bresnan 2001), as in f-structure (16) above. There is some theoretical motivation for eliminating TOPIC and FOCUS as syntactic entities (Asudeh 2011b, 2012), but I will not argue for that here. I will henceforth assume a single UNBOUNDED DEPENDENCY FUNCTION (UDF), just as an expedient simplification.

A simple functional uncertainty is the disjunction in (19), which states that the **Base** of the unbounded dependency may be a SUBJ or OBJ.

$$(19) \quad (\uparrow \text{UDF}) = (\uparrow \mathbf{Body} \{ \text{SUBJ} \mid \text{OBJ} \})$$

This equation allows the unbounded dependency to terminate in either a SUBJECT or an OBJECT by using disjunction to model uncertainty about the functional identity of **Base**. This kind of disjunction is routinely generalized by defining an f-structure metacategory, GF (‘grammatical function’), as the disjunction of all grammatical functions in the grammar (Dalrymple 2001: 140). This sort of uncertainty can be further fine-tuned using the regular language complementation operator,  $-$ . For example, if a grammar allows extraction of all grammatical functions except obliques and adjuncts, then **Base** could be written as  $[\text{GF} - \{ \text{OBL} \mid \text{ADJ} \}]$ .

Functional uncertainty of the form in (19) does not express unboundedness. This is expressed by using the Kleene star and plus operators, where Kleene  $*$  has the standard interpretation ‘zero or more’ and Kleene  $+$  has the standard interpretation ‘one or more’. Here is an example:

$$(20) \quad (\uparrow \text{UDF}) = (\uparrow \{ \text{COMP} \mid \text{XCOMP} \}^* \mathbf{Base})$$

This equation allows the unbounded dependency to pass through any sequence of COMP and XCOMP f-structures (including none).

A noteworthy consequence of this treatment of unbounded dependencies is that no empty category needs to be posited in the syntax. The extracted constituent’s base position is absent entirely in c-structure. At f-structure, the UDF grammatical function borne by the **Top** of the dependency is equated with the grammatical function of the **Base**. This is illustrated in example (16) above: there is no c-structural representation of the missing embedded subject and the relevant SUBJ grammatical function in f-structure is equated with the unbounded dependency function FOCUS contributed by the *wh*-phrase. The Kaplan and Zaenen (1989) theory thus removes extraction per se as an argument for empty categories. However, although empty categories are not necessary in c-structure, the theory does not formally preclude them, should there be some independent motivation (e.g., if Bresnan’s arguments from weak crossover are accepted (Bresnan 1995); but see Dalrymple et al. 2001, 2007, Nadathur 2013).

The Kaplan and Zaenen unbounded dependency constraints are based on a generalization of standard LFG functional application, which is outside-in, or concerns the characterization of embedded f-structures. For example, the vanilla constraint  $(\uparrow \text{TENSE}) = \text{PAST}$  states that the f-structure designated by  $\uparrow$ , which is a function, applied to the argument TENSE has value PAST; i.e.  $\langle \text{TENSE}, \text{PAST} \rangle \in \uparrow$ . This means that the attribute-value pair in question is embedded in f-structure  $\uparrow$ . Outside-in functional application can be iterated to characterize paths through embedded f-structures. For example, the standard LFG functional control equation (Bresnan 1982),  $(\uparrow \text{SUBJ}) = (\uparrow \text{XCOMP SUBJ})$ , equates the SUBJ of  $\uparrow$  with a

SUBJ embedded inside an XCOMP that is in turn embedded in  $\uparrow$ . Lastly, iterated outside-in functional application is generalized to outside-in functional uncertainty by characterizing paths from outer f-structures to inner f-structures as a succession of outside-in functional applications, where uncertainty over paths can be expressed using the regular language of f-structure constraints.

Bresnan (1995, 2001) presents an alternative theory of unbounded dependencies in which there is an empty category at the **Base** of the dependency. The empty category is associated with an inside-out equation, a different sort of f-structure constraint. The general format of inside-out unbounded dependency constraints is:

$$(21) \quad ((\mathbf{Body} \mathbf{Base} \uparrow) \mathbf{Top}) = \uparrow$$

The equivalent constraint to the particular constraint (20) on the Bresnan theory would be written as follows:

$$(22) \quad ((\{ \mathbf{COMP} \mid \mathbf{XCOMP} \}^* \mathbf{Base} \uparrow) \mathbf{UDF}) = \uparrow$$

Constraint (22) associates the f-structure of the empty category that bears the constraint with the UDF of an f-structure that contains the empty category's f-structure. The outer f-structure must be reachable from the inner f-structure that corresponds to the empty category by traversing only COMP and XCOMP f-structures.

Inside-out expressions like (22) were first introduced in unpublished work by Kaplan and first discussed in print by Halvorsen and Kaplan (1988). Inside-out expressions concern the characterization of f-structures that contain the f-structure that is the locus of the constraint. For example, the constraint (SUBJ  $\uparrow$ ) states that  $\uparrow$  must be the value of the attribute SUBJ in the f-structure that contains  $\uparrow$ ; i.e. if  $\uparrow$  is  $f$  and the f-structure that contains  $f$  is  $g$ , then  $\langle \text{SUBJ}, f \rangle \in g$ . Inside-out expressions can be iterated to characterize paths through enclosing f-structures, as in (22). Iterated inside-out expressions can be generalized to inside-out functional uncertainty by characterizing paths from inner f-structures to outer f-structures as a succession of inside-out computations, where uncertainty over paths can be expressed using the regular language of f-structure constraints. In addition to its role in Bresnan's treatment of unbounded dependencies, inside-out expressions are the key formal mechanism in Dalrymple's theory of the syntax of anaphoric dependencies (Dalrymple 1993) and Nordlinger's theory of case (Nordlinger 1998).

Island constraints (Ross 1967) are captured through constraints on **Body** and **Base**. For example, the constraints in (23) (outside-in) and (24) (inside-out) equally capture both the Sentential Subject Constraint and the Left Branch Condition (Ross 1967).

$$(23) \quad (\uparrow \mathbf{UDF}) = (\uparrow \{ \mathbf{XCOMP} \mid \mathbf{COMP} \}^* \{ \mathbf{SUBJ} \mid \mathbf{OBJ} \})$$

$$(24) \quad ((\{ \mathbf{XCOMP} \mid \mathbf{COMP} \}^* \{ \mathbf{SUBJ} \mid \mathbf{OBJ} \} \uparrow) \mathbf{UDF}) = \uparrow$$

The Sentential Subject Constraint is captured because **Body** does not contain SUBJ; the unbounded dependency cannot pass through a SUBJ f-structure, only through an XCOMP or COMP. The Left Branch Condition is captured, because the **Base** functions SUBJ and OBJ cannot be functions borne by possessors, for independent reasons.

Constraints on extraction are also captured through *off-path* constraints (Dalrymple 1993), which place restrictions on f-structures found along the path through **Body** and into **Base**. Off-path constraints can be defined as in (21), following Dalrymple (2001: 151):

- (25) a. In an expression  $\begin{matrix} a \\ (\leftarrow s) \end{matrix}$ ,  $\leftarrow$  refers to the f-structure of which  $a$  is an attribute.  
 b. In an expression  $\begin{matrix} a \\ (\rightarrow s) \end{matrix}$ ,  $\rightarrow$  refers to the value of the attribute  $a$ .

For example, *wh*-islands can be captured with an equation like the following, which states that no GF on the path to the base can have its own UDF function:<sup>2</sup>

$$(26) \quad (\uparrow \mathbf{UDF}) = (\uparrow \begin{matrix} \mathbf{GF}^* \\ \neg(\rightarrow \mathbf{UDF}) \end{matrix} \mathbf{GF})$$

The *wh*-island violation example (27) has the f-structure in (28).

(27) \*Who did John wonder what Mary gave?

<sup>2</sup> This discussion is based on Asudeh (2011b), where the issues are discussed in more detail.

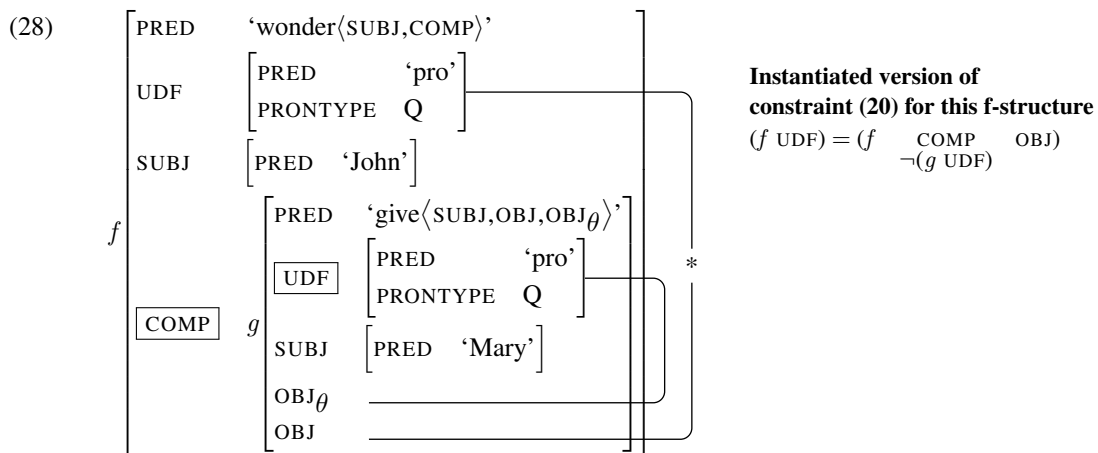

The first GF that the unbounded dependency passes through is the matrix COMP. This COMP itself contains a UDF, due to the lower extraction of *what*. The structure is therefore excluded if the grammar contains constraint (26).

#### 4. Outside-In Uncertainty and Prioritization of Local Well-Formedness

I have proposed the simplified production model in Figure 2 (Asudeh 2011a, 2012), based on the assumption that sentence production is incremental (Kempen and Hoenkamp 1987, Levelt 1989). The incrementality of the model is based on LFG’s model of the “fragmentability of language” (Bresnan 2001: 79–81), which is related to the monotonicity property.

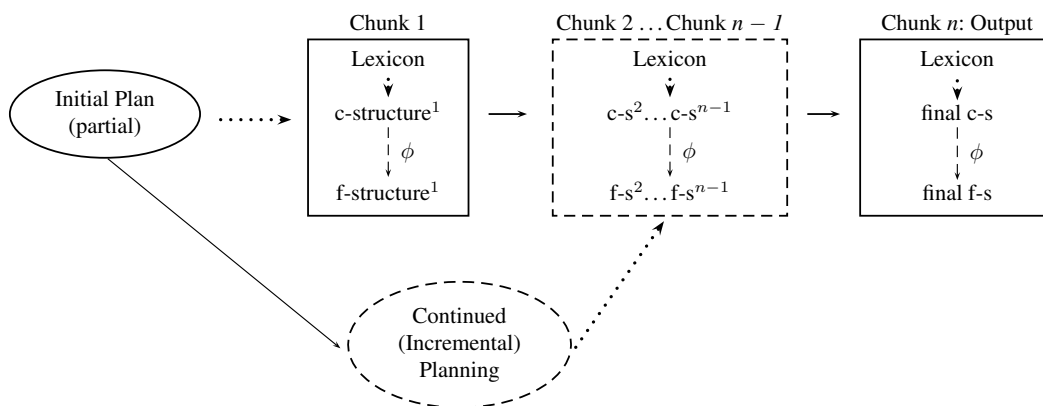

Figure 2: The production model

Bresnan notes that LFG can distinguish between informative and uninformative sentence fragments, using the f-structure representation of predicate-argument relations. The fragment ... *seems to* ..., as in (29), contrasts with the fragment ... *to by for* ..., as in (30).

(29) [Speaker A:] And he agrees?  
 [Speaker B:] — seems to.

(30) The one he should be spoken to by, for God’s sake, is his mother.

The first fragment constructs an informative partial c-structure and f-structure, which form subparts of the c-structure and f-structure for a full sentence like *He seems to agree*. The second fragment constructs only three unrelated structures (Bresnan 2001: 81). The ability to define informative fragments arises from the fact that the c-structure head/f-structure predicator contains information about the larger structures in which it can be embedded. In particular, the f-description (set of constraints) of the lexical items in the fragment defines its f-structure. In the case of fragment (29), the lexical items for *seems* and *to* in (31) construct the partial c-structure and f-structure in (32) (based on Bresnan 2001: 80–81).

- (31) *seems*     $(\uparrow \text{ PRED}) = \text{'seem(XCOMP)SUBJ'}$   
                   $(\uparrow \text{ SUBJ}) = (\uparrow \text{ XCOMP SUBJ})$   
                   $(\uparrow \text{ TENSE}) = \text{PRES}$   
                   $(\uparrow \text{ SUBJ PERSON}) = 3$   
                   $(\uparrow \text{ SUBJ NUMBER}) = \text{SING}$

*to*             $\neg (\uparrow \text{ TENSE})$

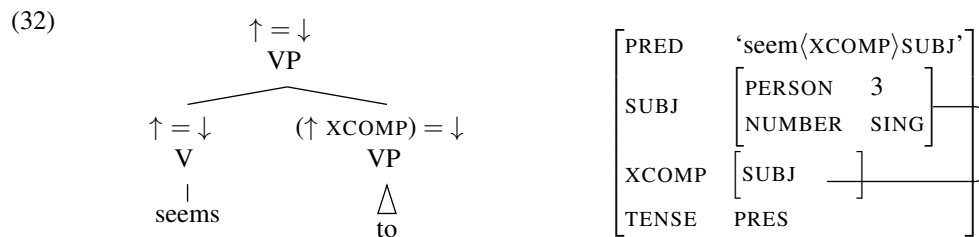

The monotonicity property dictates that the f-structure of the fragment must subsume, or be more general than, the f-structure of any larger sentence in which it might have been embedded. In other words, monotonicity restricts which sentences/propositions may be recovered from a fragment.

Levelt (1989: 258) argues that the planning units of sentence production are not determined by syntactic criteria, but rather reflect a “function-argument structure”, which he takes to be semantic in nature. The function-argument structure is something like a rough thematic structure, akin to the one offered by the Conceptual Semantics of Jackendoff (1990, 1997, among others). In order to make this more precise, I assume that when a speaker begins initial planning s/he puts together a message that identifies the event or state, its basic function/predicate, the function’s arguments and their rough thematic relation to each other. The speaker then identifies what sort of utterance s/he wants to make with respect to these elements: a declaration, a question, etc. The thematic structure of the message unfolds through incremental construction of fragments of grammatical structure. These are monotonically added to the grammatical structure computed thus far (in the absence of explicit repairs). Incremental grammatical production is ultimately based on the predicate-argument structure of heads, which is lexically encoded and will bear a close relationship to the function/argument structure of the planning unit.

LFG is a declarative, constraint-based theory and therefore does not have a notion of procedural grammatical generation. However, incremental processing is inherently procedural and involves issues of timing and ordering of operations. Procedurality of production and parsing and timing of grammatical operations are central questions in psycholinguistics (for an overview, see Frazier 1999). The model presented here captures procedurality of production through chunking. Each successive chunk of grammatical representation produced by the processing system must be grammatical in its own right — *locally well-formed* — in order to be generated. This leads to incremental generation of a grammatical structure that satisfies local grammaticality requirements at each step. However, the end result does not necessarily satisfy global grammaticality. Global well-formedness depends on successful monotonic integration of subsequent fragments, which may fail even though the fragments computed thus far are each locally well-formed.

If we assume the outside-in theory of unbounded dependencies, given the incrementality of production, there is an important consequence for the construction of locally well-formed grammatical representations. When the chunk that contains the unbounded dependency is under construction for production, the top of the unbounded dependency contributes the outside-in equation. This equation is satisfied only if an otherwise empty grammatical function is found in a subsequent, embedded f-structured. If the unbounded dependency grammatical function and an embedded grammatical function are equated, the filler at the top of the dependency and what we might call the gap at the base are successfully integrated. However, the term ‘gap’ in this context is a purely pre-theoretical one: there is no element in c-structure or f-structure that corresponds to the gap. Just as what we call a gap in the sentence is identified by the absence of local material, the only structural correlate of the absent local material is absence of structure. In other words, the gap is just nothing.

This has an important implication for incremental construction of fragments. The outside-in function contributed by the filler is unbounded and defines a path through f-structure material that is still being incrementally constructed. If the grammar cannot integrate the filler into the local f-structure being constructed because all grammatical functions are locally filled, it does not crash, because the integration site

could be in the next chunk of f-structure that is yet to be constructed or in a chunk after that. The system has the following properties:

1. The functional uncertainty equation is unbounded.
2. The equation is initiated at the top of the unbounded dependency, which corresponds to an earlier chunk in production.
3. The gap is not marked in the locally produced c-structure or f-structure.

Given these properties, it is possible to maintain a model of incremental processing in which integration of the filler by the grammar takes place after the local structure under construction has been built.

In constructing a local structure, each grammatical function (GF) can be handled by the production system in one of two ways. First, the production system can leave the GF empty; the GF must then be subsequently licensed by integration of a filler. The filler must be functionally equated with this GF before production of the next chunk, or else the local structure of the current chunk would not be well-formed. Alternatively, the production system could posit lexical material, such as a pronoun or other nominal, that will fill the GF and that is consistent with the other specifications of the local structure. For example, in English, an OBJECT pronoun must have accusative case. The lexical material that is chosen to fulfill the local requirements for the GF must also be consistent with the current message plan. If this second option is chosen, the filler is not integrated but the local structure is well-formed. The filler must instead be integrated in an upcoming chunk.

The two situations are sketched in Figures 3 and 4. Figure 3 shows what happens when the filler is integrated. Figure 4 shows what happens if the filler is passed through the local structure rather than being integrated. The second pattern is the relevant one for explaining how ungrammatical intrusives are produced instead of a gap.

## 5. A Processing-Based Explanation of English Intrusive Nominals

I now turn to two examples to better illustrate how the model of Asudeh (2011a, 2012) solves the Intrusive Nominal Puzzle, both in island and non-island contexts. I then return to the question of outside-in versus inside-out functional uncertainty in section 6.

### 5.1. Example 1: An Intrusive Where a Gap Would be Well-Formed

The first example is the Prince (1990) example in (6), which is syntactically quite simple. This not only makes it suitable for illustrative purposes, it more importantly demonstrates that this account of production does not appeal to processing complexity to explain the Prince and Kroch examples.<sup>3</sup> Example (6) is repeated here:

(33) You get a rack that the bike will sit on it.

Initiation of production is shown in (34). The local structure under construction is indicated by the dashed box. I use a common LFG convention of abbreviating the contents of f-structures with the contributing lexical item in double quotes; e.g. “you” represents PRED ‘pro’ and PERSON 2. The planned message is represented in the ellipse. It is not normally the case that an entire utterance is planned in advance (that would not be a Levelt-style model). However, the findings of Ferreira and Swets (2005) indicate that the production system plans at least far enough in advance to include a message of this length and complexity in the initial plan.

<sup>3</sup> The interaction of complexity and intrusive pronouns is discussed in Asudeh (2012).

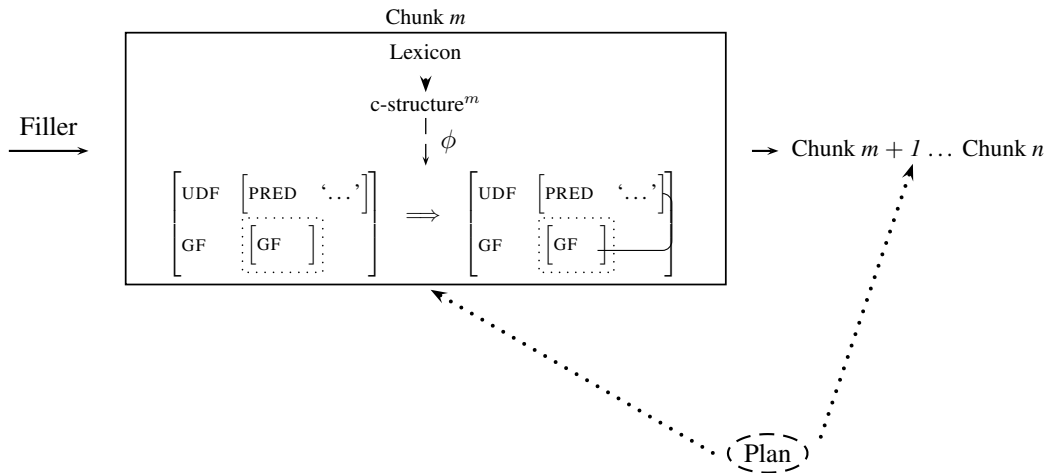

Figure 3: Local well-formedness satisfied by integration of a filler

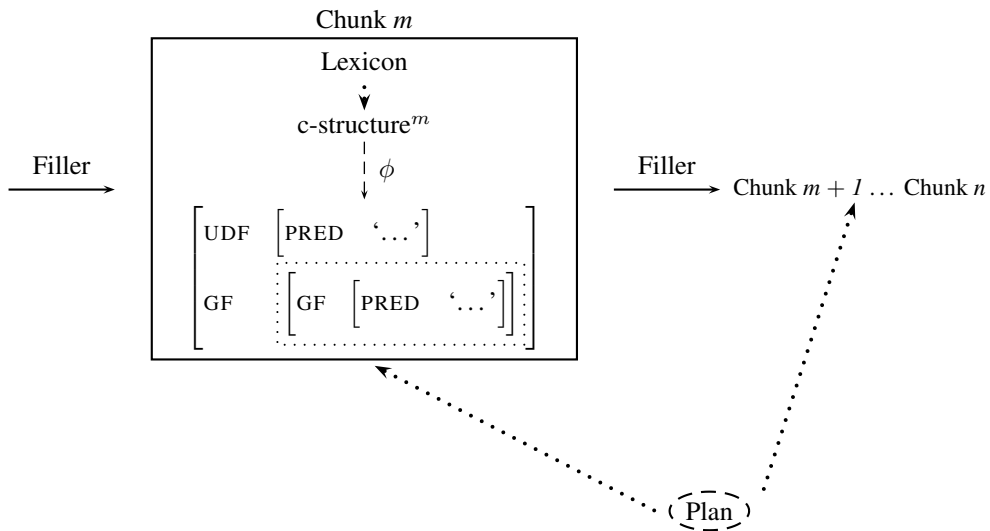
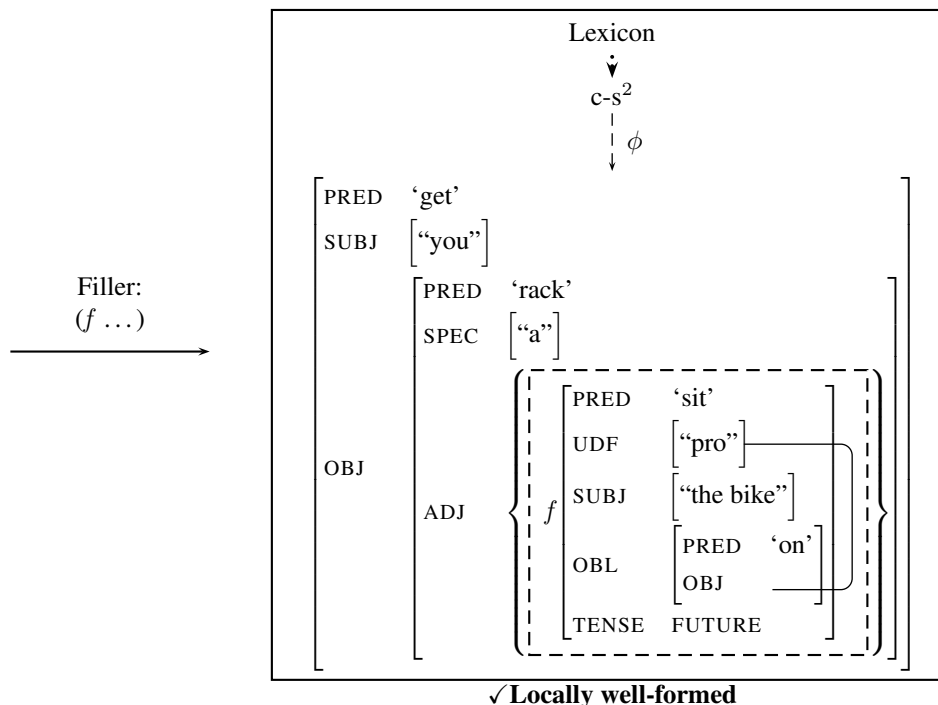

Figure 4: Local well-formedness satisfied by insertion of lexical material



(37)

Chunk 2: ... the bike will sit on



The filler is integrated into the local structure, satisfying both the demands of the filler and the local demand that the OBJ must be integrated into the f-structure. The overall construction of the sentence is illustrated here:

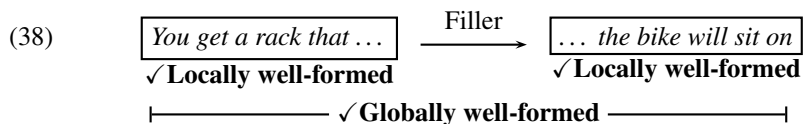

Each of the local structures here is well-formed and consistent with the plan and the overall result is also well-formed.

Chunk 2 can alternatively be constructed through the option of inserting lexical material that is consistent with the plan, as sketched in Figure 4. In this case, the Prince example (33) is produced instead. The local structure under construction is again shown in the dashed box. The pronoun *it* has been inserted as the prepositional object.

(39)

Chunk 2: ... the bike will sit on it

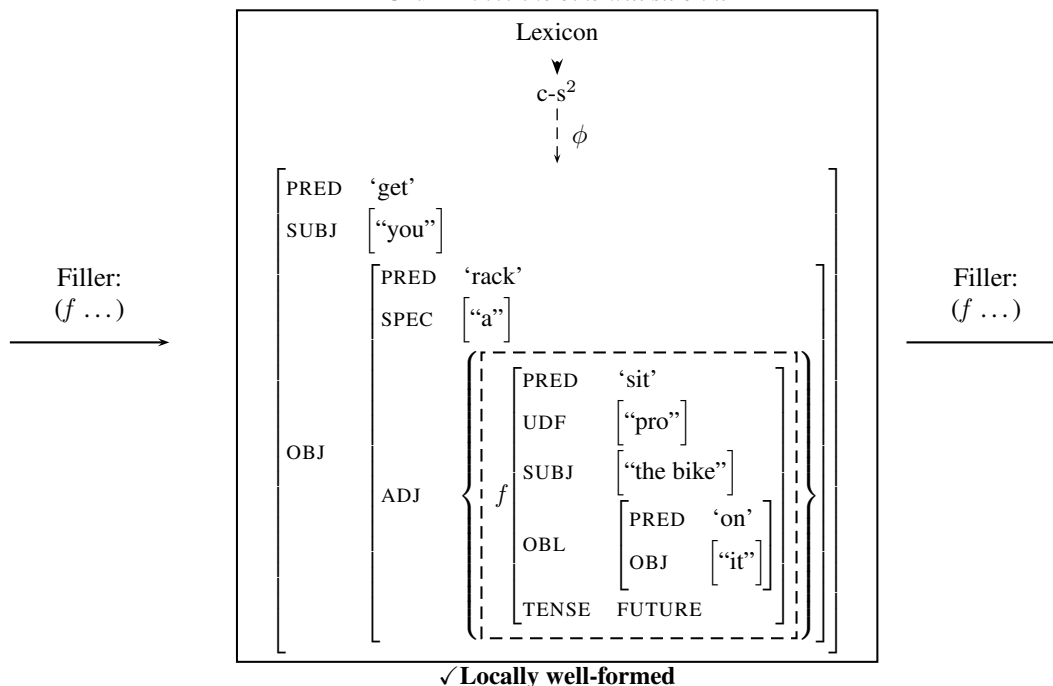

The production system passes the filler on and attempts to continue, but there is no longer anywhere to integrate the filler. There is no remaining structure to be built and insertion of the filler in the structure built so far is impossible. The situation is illustrated in (40):

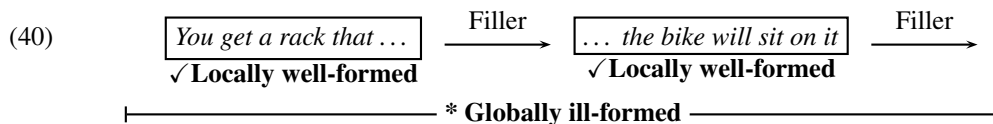

The grammar ultimately fails to license the structure that has been attempted. However, due to incremental production of locally well-formed structures, the ungrammatical sentence has been produced; i.e. it is uttered. Incremental production nevertheless treats each stage of producing (33) as locally grammatical. The result of production is, however, globally ungrammatical and is perceived as such by native speakers. The perception of ungrammaticality does not arise through production, but rather through parsing. What the parser does with the result of productions like (33) is considered in detail in Asudeh (2012).

The question arises of what constraints there are on the construction of locally well-formed grammatical structures through lexical filling (Figure 4) — which is what leads to the construction of sentences like *You get a rack that the bike will sit on it*. If there are no grammatical constraints, then this sentence and other intrusive nominal sentences are effectively speech errors. I do not think the relevant sentences are speech errors in this sense. First, they are constrained at the level of local grammatical structure by the kinds of local structure that can be well-formed. For example, in constructing the sentence *You get a rack that the bike will sit on it*, insertion of a pronoun as the object of *on* is locally licensed by the rule that constructs PPs, the lexical requirements of *on* which require an OBJ, the fact that the OBJ of *on* must be realized by a nominal, etc. If local grammatical well-formedness is a criterion, then speakers could not instead produce things like *You get a rack that the bike will sit it*. If this kind of form is produced at all, it really is a speech error. This must be distinguished from locally well-formed structures that arise from purely incremental production. Second, the kinds of things that can be inserted are constrained by the plan itself. If the speaker wants to say something about a rack, then s/he will select a lexical item that is consistent with that plan. In English, the kinds of lexical items that are consistent with the plan are pronouns (*it*), deictics (*that*), names and definite descriptions that refer to the thing in question (*the rack*), and epithets (*the damn thing*). Third, the findings of Ferreira and Swets (2005) indicate that speakers produce these utterances even when given time to plan carefully (no-deadline experiment). The utterances are thus more deliberate than speech errors.

5.2. Example 2: An Intrusive Where a Gap Would be Ill-Formed

The more interesting case is that of island violations like the Ferreira and Swets donkey example, repeated here, or Creswell’s attested example in (42).

- (41) This is a donkey that I don’t know where it lives.  
(Swets and Ferreira 2003)
- (42) You have the top 20% that are just doing incredible service, and then you have the group in the middle that a high percentage of those are giving you a good day’s work ...  
(Creswell 2002: 102, (4d); <http://www.ssa.gov/history/WEIKEL.html><sup>4</sup>)

The explanation of these cases basically reduces to the case that we have already looked at plus the fact that the island prevents integration of the filler.

Let us use the simpler donkey example as an illustration of island-intrusive cases. Production starts as follows:

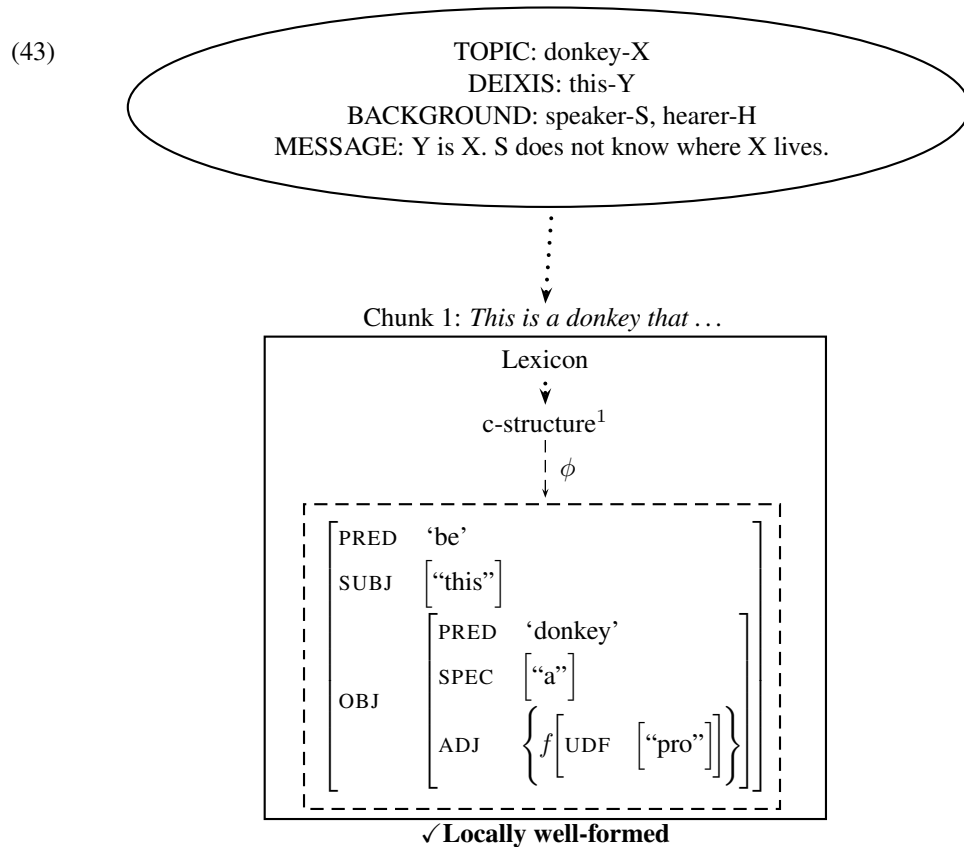

An unbounded dependency is once again launched by the relativizer. Let us assume that the *wh*-island constraint is stated as an off-path equation to the effect that the functional uncertainty cannot pass through a COMP that contains a UDF, as discussed in section 3.2. A simplified version of the functional uncertainty is shown here:

$$(44) \quad (\uparrow \text{UDF}) = (\uparrow \text{COMP}^* \text{GF}) \quad \neg (\rightarrow \text{UDF})$$

The equation states that the grammatical function to be equated with the UDF can be found by going through zero or more COMP f-structures and none of the COMP f-structures may have an unbounded dependency function (UDF) of its own. After construction of the first chunk, the UDF has not been integrated and the beginning of the path has already been instantiated to one COMP.

In producing the next chunk,<sup>5</sup> the production system constructs the following partial local structure (indicated by the dotted box):

<sup>4</sup> See <http://web.archive.org/web/20041217051431/http://www.ssa.gov/history/WEIKEL.html> (retrieved May 9, 2013).

<sup>5</sup> I assume for simplicity that the next chunk is the remainder of the sentence. Nothing depends on this.

(45)

Chunk 2: ... *I don't know where it lives*

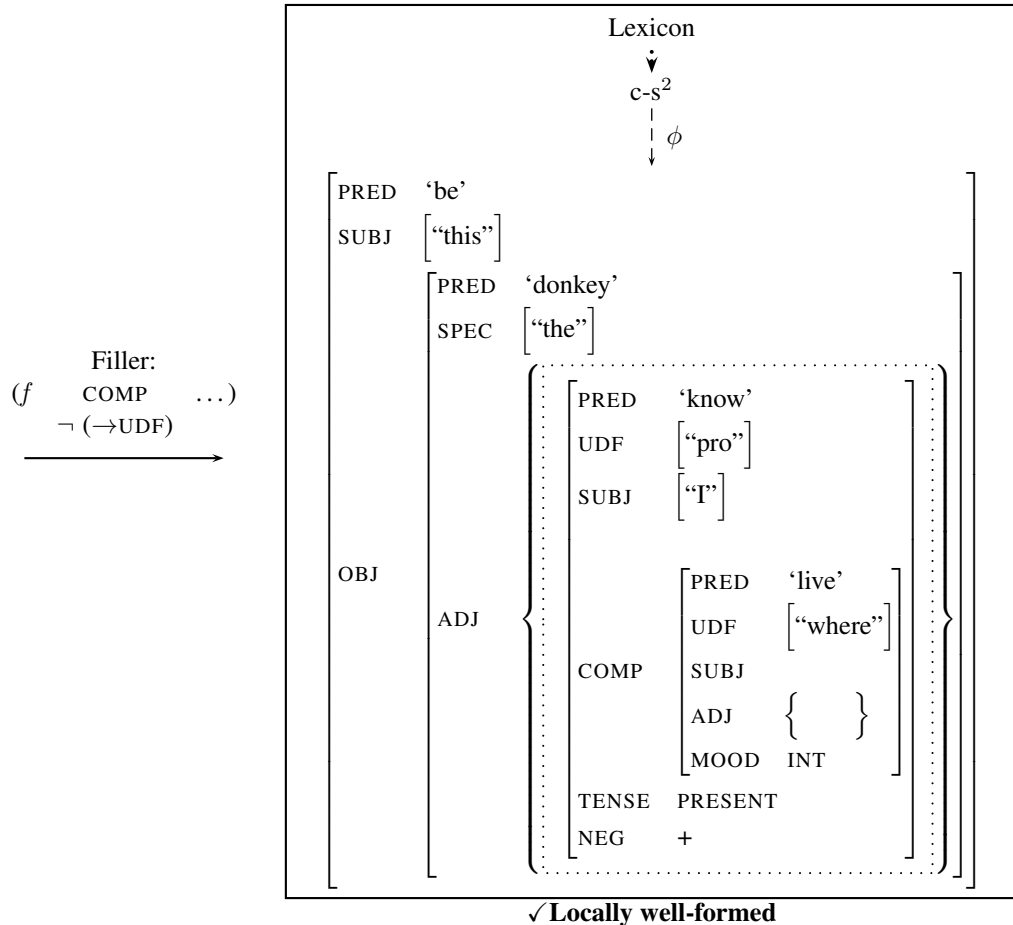

In this chunk, the production system still has an unintegrated unbounded dependency and now it has encountered a new one. The option of positing a gap for the most deeply embedded SUBJ, as in Figure 3, does not exist. The presence of the embedded UDF means that there is no way to locally satisfy the relative clause's functional uncertainty equation. There is also no global way to satisfy the equation. As soon as a COMP containing a UDF is encountered, satisfaction is impossible. The result is that the only way to construct a locally well-formed f-structure is through the option in Figure 4 of inserting some lexical material that is consistent with the plan (i.e., that refers to the donkey). The filler does not pass through the chunk, though, because it cannot do so and satisfy the unbounded dependency equation. The new unbounded dependency also needs to be integrated, but this can be done using the gap integration option in Figure 3, because there is no embedded in UDF in the way of the lower integration.

The final local structure is shown here in the dashed box:

(46)

Chunk 3: ... *I don't know where it lives*

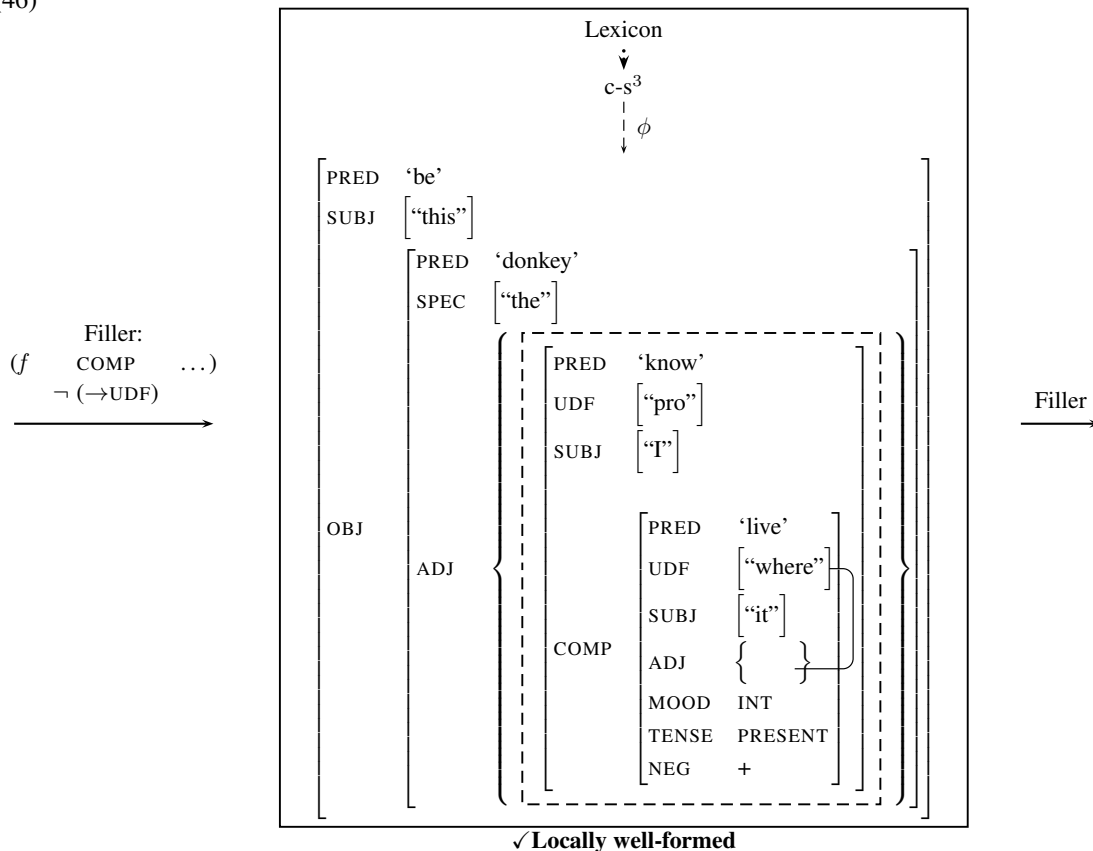

Since the local structure is an island, there is no way for the filler to be integrated. The situation is sketched here:

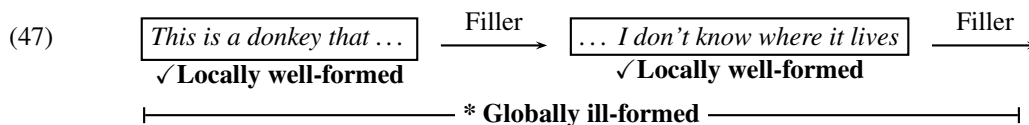

Once again, the grammar ultimately fails to sanction the structure that has been attempted. However, the sentence can be uttered due to incremental production of locally well-formed structures.

### 5.3. Summary

The grammatical architecture of LFG and the production model proposed in Asudeh (2011a, 2012), reviewed here, offers a solution to the Intrusive Nominal Puzzle. Sentences containing intrusive nominals *are* deemed ungrammatical by native speakers, because they are underlyingly ungrammatical. Nevertheless, the sentences in question can be produced by these speakers through the interaction of fundamental properties of the overall system. Incremental production is modelled as monotonic growth of syntactic structure through integration of fragments. Each fragment must be locally well-formed. Local well-formedness depends in part on successful integration of all grammatical functions. The two strategies for the latter are insertion of lexical material or equating the grammatical function with a filler that has previously been introduced. Insertion of lexical material can guarantee local well-formedness in cases where filler integration is impossible (islands).

## 6. The Importance of Directionality

The explanation of intrusive nominal productions rests partly on a prioritization of local well-formedness over global well-formedness. Another important aspect of the explanation is that the unbounded dependency's functional uncertainty equation is outside-in. If the production system is working with an outside-in unbounded dependency equation, then it is not determinate that any given local structure is the correct integration site, because the site may be in an upcoming fragment yet to be constructed. Local

well-formedness is then achieved through the strategy of positing lexical material (rather than by integrating the top of the unbounded dependency), as sketched in Figure 4. In the case of an island, the local structure can only be locally well-formed using the lexical insertion strategy. Importantly, as the island is being constructed by the production system, it is already determinate that the unbounded dependency integration strategy is unavailable, due to the outside-in equation that has already been generated when the top of the dependency was produced.

Both the island and non-island situations for outside-in functional uncertainty contrast with what would have to logically be the case if the unbounded dependency were instead licensed by an inside-out functional uncertainty associated with a gap. In the non-island case, if a gap is posited, then the system will need to search all of the structure grown so far for an associated filler. This contrasts with the outside-in alternative, where the constraint can be checked successively as each chunk of structure is added. The final check when the gap is encountered is then effectively just a local check. The island case offers an additional point of divergence. In the inside-out alternative, the unbounded dependency constraint is associated with an empty category. The unbounded dependency constraint specifies all the licit ways in which the gap can be associated with a filler; by definition, island violations are illicit associations of filler and gap. Therefore, the fact that the local structure is an island is only registered by the grammar if the gap is posited. Therefore, on the inside-out alternative, it is not determinate that a gap would lead to local ill-formedness until the empty category corresponding to the gap is in fact generated. In short, this would mean, as far as the production system is concerned, that local well-formedness is equally plausible given either the filler-gap strategy (Figure 3) or the lexical insertion strategy (Figure 4). We would then expect to see roughly equal distributions of the two strategies in production of island sentences. This is emphatically not the case. For example, Swets and Ferreira (2003) report that the proportion of actual *wh*-island gaps produced in the *wh*-island condition (i.e., island-intrusive condition) were 1.4% for the no-deadline experiment and 3.1% for the deadline experiment.

The thrust of the outside-in/inside-out contrast remains even if island constraints are partly or wholly extra-grammatical in nature, as argued by Deane (1991), Kluender (1991, 1998), Kluender and Kutas (1993), and Hofmeister and Sag (2010), among others.<sup>6</sup> If island constraints are not part of the grammar, then the unbounded dependency constraints would be simplified. Specifically, the off-path constraints would not be required and the **Base** of the dependency could possibly be unrestricted (i.e., fully general as to possible grammatical function of the gap). The important distinction between the two kinds of constraints is that the outside-in constraint can already be checked outside the island (however it is defined), whereas the inside-out constraint can only be checked once the gap has been posited in the island.

## 7. Conclusion

I have reviewed a model of the language faculty in which production is monotonically incremental (Asudeh 2011a, 2012). Crucially, with respect to directionality, I have argued that unbounded dependency constraints are generated outside-in (working in the direction *less embedded to more embedded*; i.e. from an outer f-structure to an inner f-structure), rather than inside-out (working in the direction *more embedded to less embedded*; i.e. from an inner f-structure to an outer f-structure). I also assumed that the processing system prioritizes local well-formedness over global well-formedness. Effectively, processing resources are concentrated on a relatively small piece of structure at a time.

This system allows a natural, although surprising, explanation of the Intrusive Nominal Puzzle. Intrusive nominals are produced because the structures that contain them are locally well-formed. However, speakers nevertheless judge them as ungrammatical, because English does not have the grammatical resources to properly license resumptive pronouns. As a result, sentences containing intrusive pronouns and other intrusive nominals are globally ill-formed. In other words, through the normal constraints of the production system, speakers are, in certain circumstances, monotonically and incrementally producing sentences that are underlying ungrammatical.

With respect to the issue of directionality, this paper makes two key points. The first is that there is a distinction in predicted outcomes for production of intrusive nominals in islands, depending on whether the unbounded dependency constraint can be checked outside of the island or only once inside the island. I argued that the outside-in alternative comports better with Ferreira and Swets's production study. I do not think this is necessarily an LFG-specific argument, but rather a distinction between theories in which islands are identified internally to the island (e.g., Principles & Parameters Theory, TAG; Chomsky

<sup>6</sup> See Sprouse and Hornstein (2013) for a recent collection of psycholinguistically-motivated papers on this debate.

1973, 1986, 2001, Frank 2002), versus those in which islands are or can be identified externally to the island (e.g., Categorical Grammar and HPSG; Steedman 1987, Morrill 1994, 2011, Pollard and Sag 1994, Bouma et al. 2001, Levine and Hukari 2006). In fact, the distinction seems relevant even if islands are completely or in part extra-grammatical, since the model relies on a mix of grammatical and processing factors. The second, more general point is that LFG's outside-in and inside-out constraints are rich loci for investigation of questions of grammatical directionality, even in a framework that is non-derivational.

## References

- Alexopoulou, Theodora, and Frank Keller. 2002. Resumption and Locality: A Crosslinguistic Experimental Study. In Mary Andronis, Erin Debenport, Anne Pycha, and Keiko Yoshimura, eds., *CLS 38: The Main Session*, vol. 1. Chicago, IL: Chicago Linguistic Society.
- . 2007. Locality, Cyclicity, and Resumption: At the Interface between the Grammar and the Human Sentence Processor. *Language* 83(1): 110–160.
- Asudeh, Ash. 2004. Resumption as Resource Management. Ph.D. thesis, Stanford University.
- . 2006. Direct Compositionality and the Architecture of LFG. In Miriam Butt, Mary Dalrymple, and Tracy Holloway King, eds., *Intelligent Linguistic Architectures: Variations on Themes by Ronald M. Kaplan*, 363–387. Stanford, CA: CSLI Publications.
- . 2011a. Local Grammaticality in Syntactic Production. In Emily M. Bender and Jennifer E. Arnold, eds., *Language from a Cognitive Perspective*, 51–79. CSLI Publications.
- . 2011b. Towards a Unified Theory of Resumption. In Alain Rouveret, ed., *Resumptive Pronouns at the Interfaces*, 121–187. Amsterdam: John Benjamins.
- . 2012. *The Logic of Pronominal Resumption*. Oxford: Oxford University Press.
- Asudeh, Ash, and Ida Toivonen. 2009. Lexical-Functional Grammar. In Bernd Heine and Heiko Narrog, eds., *The Oxford Handbook of Linguistic Analysis*, 425–458. Oxford: Oxford University Press.
- Bard, Ellen Gurman, Dan Robertson, and Antonella Sorace. 1996. Magnitude Estimation of Linguistic Acceptability. *Language* 72(1): 32–68.
- Bouma, Gosse, Robert Malouf, and Ivan A. Sag. 2001. Satisfying Constraints on Extraction and Adjunction. *Natural Language and Linguistic Theory* 19: 1–65.
- Bresnan, Joan. 1982. Control and Complementation. *Linguistic Inquiry* 13(3): 343–434.
- . 1995. Linear Order, Syntactic Rank, and Empty Categories: On Weak Crossover. In Dalrymple et al. 1995, 241–274.
- . 2001. *Lexical-Functional Syntax*. Oxford: Blackwell.
- Butt, Miriam, Mary Dalrymple, and Anette Frank. 1997. An Architecture for Linking Theory in LFG. In Miriam Butt and Tracy Holloway King, eds., *Proceedings of the LFG97 Conference*. Stanford, CA: CSLI Publications.
- Chao, Wynn, and Peter Sells. 1983. On the Interpretation of Resumptive Pronouns. In Peter Sells and Charles Jones, eds., *The Proceedings of NELS 13*, 47–61. Amherst, MA: GLSA.
- Chomsky, Noam. 1973. Conditions on Transformations. In Stephen Anderson and Paul Kiparsky, eds., *A Festschrift for Morris Halle*, 233–285. New York: Holt, Rinehart and Winston.
- . 1981. *Lectures on Government and Binding*. Dordrecht: Foris.
- . 1986. *Barriers*. Cambridge, MA: MIT Press.
- . 1995. *The Minimalist Program*. Cambridge, MA: MIT Press.
- . 2001. Derivation by Phase. In Michael Kenstowicz, ed., *Ken Hale: A Life in Language*, 1–50. Cambridge, MA: MIT Press.

- Chomsky, Noam, and George Miller. 1963. Introduction to the Formal Analysis of Natural Languages. In R. Duncan Luce, Robert R. Bush, and Eugene Galanter, eds., *The Handbook of Mathematical Psychology*, vol. 2, 269–321. New York: Wiley.
- Creswell, Cassandre. 2002. Resumptive Pronouns, Wh-island Violations, and Sentence Production. In *Proceedings of the Sixth International Workshop on Tree Adjoining Grammar and Related Frameworks (TAG+ 6)*, 101–109. Università di Venezia.
- Dalrymple, Mary. 1993. *The Syntax of Anaphoric Binding*. Stanford, CA: CSLI Publications.
- . 2001. *Lexical Functional Grammar*. San Diego, CA: Academic Press.
- . 2006. Lexical Functional Grammar. In Keith Brown, ed., *Encyclopedia of Language and Linguistics*, 82–94. Amsterdam: Elsevier, 2nd edn.
- Dalrymple, Mary, Ronald M. Kaplan, and Tracy Holloway King. 2001. Weak Crossover and the Absence of Traces. In Miriam Butt and Tracy Holloway King, eds., *Proceedings of the LFG01 Conference*, 66–82. Stanford, CA: CSLI Publications.
- . 2007. The Absence of Traces: Evidence from Weak Crossover. In Annie Zaenen, Jane Simpson, Tracy Holloway King, Jane Grimshaw, Joan Maling, and Christopher Manning, eds., *Architectures, Rules, and Preferences: Variations on Themes by Joan W. Bresnan*. Stanford, CA: CSLI Publications.
- Dalrymple, Mary, Ronald M. Kaplan, John T. Maxwell III, and Annie Zaenen, eds. 1995. *Formal Issues in Lexical-Functional Grammar*. Stanford, CA: CSLI Publications.
- Deane, Paul. 1991. Limits to Attention: A Cognitive Theory of Island Phenomena. *Cognitive Linguistics* 2: 1–62.
- Ferreira, Fernanda. 2000. Syntax in Language Production: An Approach Using Tree-adjoining Grammars. In Linda Wheeldon, ed., *Aspects of Language Production*. Philadelphia, PA: Psychology Press.
- Ferreira, Fernanda, and Benjamin Swets. 2002. How Incremental Is Language Production? Evidence from the Production of Utterances Requiring the Computation of Arithmetic Sums. *Journal of Memory and Language* 46: 57–84.
- . 2005. The Production and Comprehension of Resumptive Pronouns in Relative Clause "Island" Contexts. In Anne Cutler, ed., *Twenty-first Century Psycholinguistics: Four Cornerstones*, 263–278. Mahway, NJ: Lawrence Erlbaum Associates.
- Frank, Robert. 2002. *Phrase Structure Composition and Syntactic Dependencies*. Cambridge, MA: MIT Press.
- Frank, Robert, and William Badecker. 2001. Modeling Syntactic Encoding with Incremental Tree-Adjoining Grammar. In *Proceedings of the 14th Annual CUNY Conference on Human Sentence Processing*. University of Pennsylvania.
- Frazier, Lyn. 1999. *On Sentence Interpretation*. Dordrecht: Kluwer.
- Ginzburg, Jonathan, and Ivan A. Sag. 2000. *Interrogative Investigations: The Form, Meaning and Use of English Interrogatives*. Stanford, CA: CSLI Publications.
- Halvorsen, Per-Kristian, and Ronald M. Kaplan. 1988. Projections and Semantic Description in Lexical-Functional Grammar. In *Proceedings of the International Conference on Fifth Generation Computer Systems*, 1116–1122. Institute for New Generation Systems, Tokyo. Reprinted in Dalrymple et al. (1995: 279–292).
- Hofmeister, Philip, and Elisabeth Norcliffe. 2013. Does Resumption Facilitate Sentence Comprehension? In Philip Hofmeister and Elisabeth Norcliffe, eds., *The Core and the Periphery: Data-Driven Perspectives on Syntax Inspired by Ivan A. Sag*. Stanford, CA: CSLI Publications.
- Hofmeister, Philip, and Ivan A. Sag. 2010. Cognitive Constraints and Island Effects. *Language* 86.
- Jackendoff, Ray. 1990. *Semantic Structures*. Cambridge, MA: MIT Press.

- . 1997. *The Architecture of the Language Faculty*. Cambridge, MA: MIT Press.
- . 2007. *Language, Consciousness, Culture: Essays on Mental Structure*. Cambridge, MA: MIT Press.
- Joshi, Aravind K., Leon S. Levy, and Masako Takahashi. 1975. Tree Adjunct Grammars. *Journal of Computer and System Sciences* 10(1): 136–163.
- Kaplan, Ronald M. 1987. Three Seductions of Computational Psycholinguistics. In Peter Whitelock, Mary McGee Wood, Harold L. Somers, Rod Johnson, and Paul Bennett, eds., *Linguistic Theory and Computer Applications*, 149–181. London: Academic Press. Reprinted in Dalrymple et al. (1995: 339–367).
- . 1989. The Formal Architecture of Lexical-Functional Grammar. In Chu-Ren Huang and Keh-Jiann Chen, eds., *Proceedings of ROCLING II*, 3–18. Reprinted in Dalrymple et al. (1995: 7–27).
- Kaplan, Ronald M., and Joan Bresnan. 1982. Lexical-Functional Grammar: A Formal System for Grammatical Representation. In Joan Bresnan, ed., *The Mental Representation of Grammatical Relations*, 173–281. Cambridge, MA: MIT Press. Reprinted in Dalrymple et al. (1995: 29–135).
- Kaplan, Ronald M., and Jürgen Wedekind. 1993. Restriction and Correspondence-Based Translation. In *Proceedings of the 6th Meeting of the EACL*. European Chapter of the Association of Computational Linguistics, University of Utrecht.
- Kaplan, Ronald M., and Annie Zaenen. 1989. Long-Distance Dependencies, Constituent Structure, and Functional Uncertainty. In Mark Baltin and Anthony Kroch, eds., *Alternative Conceptions of Phrase Structure*, 17–42. Chicago, IL: University of Chicago Press. Reprinted in Dalrymple et al. (1995: 137–165).
- Kempen, Gerard, and Edward Hoenkamp. 1987. An Incremental Procedural Grammar for Sentence Formulation. *Cognitive Science* 11(3): 201–258.
- King, Tracy Holloway. 1995. *Configuring Topic and Focus in Russian*. Stanford, CA: CSLI Publications.
- Kleene, Stephen C. 1956. Representation of Events in Nerve Nets and Finite Automata. In Claude Shannon and John McCarthy, eds., *Automata Studies*, 3–41. Princeton, NJ: Princeton University Press.
- Kluender, Robert. 1991. Cognitive Constraints on Variables in Syntax. Ph.D. thesis, University of California, San Diego, La Jolla, CA.
- . 1998. On the Distinction between Strong and Weak Islands: A Processing Perspective. In Louise McNally and Peter W. Culicover, eds., *The Limits of Syntax*, 241–279. San Diego, CA: Academic Press.
- Kluender, Robert, and Marta Kutas. 1993. Bridging the Gap: Evidence from ERPs on the Processing of Unbounded Dependencies. *Journal of Cognitive Neuroscience* 5: 196–214.
- Kroch, Anthony S. 1981. On the Role of Resumptive Pronouns in Amnestying Island Constraint Violations. In *Papers from the 17th Regional Meeting of the Chicago Linguistic Society*, 125–135. Chicago, IL: Chicago Linguistic Society.
- Lascarides, Alex, and Ann Copestake. 1999. Default Representation in Constraint-Based Frameworks. *Computational Linguistics* 25: 55–105.
- Levelt, Willem J. M. 1989. *Speaking: From Intention to Articulation*. Cambridge, MA: MIT Press.
- Levine, Robert D., and Thomas E. Hukari. 2006. *The Unity of Unbounded Dependency Constructions*. Stanford, CA: CSLI Publications.
- McDaniel, Dana, and Wayne Cowart. 1999. Experimental Evidence for a Minimalist Account of English Resumptive Pronouns. *Cognition* 70: B15–B24.
- Morrill, Glyn V. 1994. *Type Logical Grammar*. Dordrecht: Kluwer.
- . 2011. *Categorial Grammar: Logical Syntax, Semantics, and Processing*. Oxford: Oxford University Press.

- Nadathur, Prerna. 2013. Weak Crossover and the Direct Association Hypothesis. Ms., University of Oxford.
- Nordlinger, Rachel. 1998. *Constructive Case: Evidence from Australian Languages*. Stanford, CA: CSLI Publications.
- Phillips, Colin. 2003. Linear Order and Constituency. *Linguistic Inquiry* 34(3): 37–90.
- Pollard, Carl, and Ivan A. Sag. 1987. *Information-Based Syntax and Semantics*. CSLI Publications.
- . 1994. *Head-driven Phrase Structure Grammar*. Chicago, IL and Stanford, CA: The University of Chicago Press and CSLI Publications.
- Prince, Ellen. 1990. Syntax and Discourse: A Look at Resumptive Pronouns. In Kira Hall, Jean-Pierre Koenig, Michael Meacham, Sondra Reinman, and Laurel Sutton, eds., *Proceedings of the Sixteenth Annual Meeting of the Berkeley Linguistics Society*, 482–497. Berkeley, CA: Berkeley Linguistics Society.
- Ross, John R. 1967. Constraints on Variables in Syntax. Ph.D. thesis, MIT.
- Sells, Peter. 1984. Syntax and Semantics of Resumptive Pronouns. Ph.D. thesis, University of Massachusetts, Amherst.
- Sprouse, Jon, and Norbert Hornstein, eds. 2013. *Experimental Syntax and Island Effects*. Cambridge University Press. To appear, Fall 2013.
- Steedman, Mark. 1987. Combinatory Grammars and Parasitic Gaps. *Natural Language and Linguistic Theory* 5: 403–440.
- Stevens, Stanley Smith. 1956. The Direct Estimation of Sensory Magnitudes — Loudness. *American Journal of Psychology* 69: 1–25.
- . 1975. *Psychophysics: Introduction to its Perceptual, Neural, and Social Prospects*. New York: John Wiley.
- Swets, Benjamin, and Fernanda Ferreira. 2003. The Effect of Time Pressure on the Production of Resumptive Pronoun Relative Clauses. Poster presented at the Sixteenth Annual CUNY Conference on Human Sentence Processing.
- Xiang, Ming, Dustin Heestand, and Maria Polinsky. 2008. Resumptive Pronouns: (Non)rescuing Function? Poster presented at the Twenty-First Annual CUNY Conference on Human Sentence Processing.