

THE SYNTACTIC TYPE OF ROMANIAN. THE BASIC SENTENCE

LAURENȚIU THEBAN

1. INTRODUCTION

1.1. Typology

Typology is, of necessity, about many languages – preferably not related historically, not contiguous areally, not important extralinguistically. Its older, classificatory concerns have given way to a more important objective, that of accompanying and advising pure theoretical linguistics¹ (which is either monolingual at the base, or so abstract as to be free from any indebtedness towards concrete languages). No version of universal grammar can be seriously accepted unless it has been guided by typology in the first place. Orientalism, for instance, is a valuable companion to general typology.

Typology can be promoted, occasionally, with a single language in view² but is more profitably conducted with respect to two, three or seven languages; in a contrastive framework true typological research, however, aspires to near-universality in its coverage. A monolingual description can be given a typological garb thanks to a recent technique, known as “helicopter-linguistics”, which picks out small pieces of information about odd languages from writings of friends and condisciples. Typology can also emerge from direct, corpus-based research and field work – most of the times sentimentally and culturally motivated – on a number of select languages spoken in distant parts of the world.

¹ Laurențiu Theban, “Géographie linguistique, typologie, sociolinguistique”, RRL, XIII, 1968, 6 : 659–663; (with Maria Theban), “Propoziția romanică și universalitățile sintactice”, SCL, XX, 1969, 1 : 55–62; “La typologie de la domination catégorielle”, in *Actes du X^e Congrès International des Linguistes*, III, București, 1970 : 647–655 (republished as “Typology of Categorical Domination”, *Language Forum*, III, 1977, 1 : 1–11, New Delhi); “Aspects nouveaux de la théorie de la syntaxe”, RRL, XVI, 1971, 2 : 91–113; “La grammaire générative et la typologie linguistique”, in *Recherches sur la Philosophie des Sciences*, București, 1971 : 543–553; “On the Theoretical Basis of Contrastive Syntax”, in *English-Romanian Contrastive Linguistics Analysis Project*, I, 1971 : 81–90; “Le modèle génératif, la syntaxe fonctionnelle et la typologie de l’ordre des mots”, CLTA, VIII, 1971 : 135–149; “Tendințe actuale în tipologia lingvistică. Importanța limbilor orientale pentru studiul gramaticii universale”, in *Progresele Științei*, VII, 1971, 10 : 493–95; (with Maria Theban), “La syntaxe des langues romanes et l’universalité des structures profondes”, BSRLR, VIII, 1971–72 : 23–36.

² L. Theban, “Le type syntaxique du fidjien”, RRL, XV, 1970, 1 : 63–86; “Structuri sintactice și semantice nucleare în limba română vorbită (Oltenia)”, FD, VIII, 1972 : 31–42; “La langue goanaise”, RRL, XXI, 1976, 1 : 109–115; N. Anghelescu, *Limba arabă în perspectivă tipologică*, București, 2000.

RRL, LI, 1, p. 179–194, București, 2006

Syntactic typology (or typological syntax) was first proposed and evolved within Romanian linguistics³ in 1965. In the last four decades or so, the Romanian model of typological syntax has had no reason to change or to break with its initial tenets, which have been, basically, the following two: everything that is universal in the structure of kernel sentences belongs to the content plane and is to be relegated to the new compartment of SEMANTAX, while SYNTAX proper (relational syntax) has to be restored full freedom to vary typologically across languages. In brief, syntax has no universality about it; semantax, in return, is not typologically diverse from one language to another.

1.2. Universal semantax

Universal semantax⁴ has been created as an isolated chapter of Romanian linguistics and has proposed a definitive set of seven ACTANTS articulated in the deepest kernel structures: Causer (initial Agent; Ai, C), Executant (Causee, middle Agent; Am, A), Instrument and Force (final Agent; Af, I), Patient (P), Source (initial Locative; Li, S), Path (middle Locative; Lm, T) and Beneficiary (final Locative; Lf, B).⁵

Elsewhere, the term «actant» has migrated loosely from one subfield or level to another; in Romanian semantactic theory, «actants» are strictly defined as structural concepts, as universal deep roles. «Actants» are not synonymic to «surface syntactic functions» (subject, complement of direct object, c. of indirect o., circumstantial c.) nor to prestructured «participants» (*Ionescu, Popescu, Jones, Smith*, etc.). In semantax, actants refer exclusively and consistently to Causers, Executants, Instruments, Patients, Sources, Paths and Beneficiaries. The most complex actantial or semantactic structures may be interpreted syntactically either by a one-verb sentence, or by a pluriverbal microtextual unit. Therefore semantax warrants the extension of sentence grammar to text grammar. For instance, consider the following microtextual structures:

... *pe malul râului Guadiana* (T), *pe care trebuia să-l treacă*, ... *nu era nici luntre* (IP), *nici corabie* (IP), *nici cine* (AP) *să-l treacă*, *pe el* (CP) *și turma* (P) *lui*, *de cealaltă parte* (B)... *Văzu un pescar* (AP), *intră în vorbă cu el* (AP) *și se tocni*

³ L. Theban, “Schiță a structurilor gramaticale fundamentale ale limbii hindi”, in *Omagiu lui A. Rosetti*, București, 1965: 907–13 (“... puncte de plecare în cercetarea... tipologiei sintactice a limbilor indo-ariene...”: 912).

⁴ The first mention of the transparent, neological term SEMANTAX appeared in Maria Theban, “Tema indígena e estilo brasileiro. Semantaxe dos verbos de percepção e comunicação em *Iracema*”, RRL, XXII, 1977, 2 : 237–42. See also L. Theban, “Pour une sémantaxe roumaine”, RRL, XXV, 1980 : 23–36.

⁵ For a fuller (systemic and structural) presentation, see L. Theban, “Pour un modèle roumain des structures d’actance”, RRL, XLIX, 2003, 1–4 : 159–62. The term ACTANT was first proposed as a semantactic function or role in L. Theban, “Os níveis de estruturação das orações nucleares”, in *Novas Perspectivas das Ciências do Homem*, Lisboa, 1971: 195–219. For a recent, comparative assessment, L. Theban, “*Kāraka*, (Deep) Case, Theta-Role, Actant”, paper read at the Symposium “Concepte trans- și inter- culturale”, University of Bucharest, May 2006.

să-l treacă pe el (CP) și cele trei sute de capre (P)... (I. Frunzetti, E. Papu, translation of Cervantes, *Don Quijote*).⁶

Whether surfaced as a kernel sentence or as a multipropositional text unit, the deep (semantactic or actantial) structure of the period above is articulated as follows:

CP₁ îl pune pe AP₂ să-i treacă T pe el (CP₁) și P₄ cu barca (IP₃) de cealaltă parte (B); [CP₁ has AP₂ carry / ferry him (CP₁) and P₄ over T in IP₃ to B].

Prutul (S) pusese Neculai-Vodă (C₂), de la Poartă (C₁) având poruncă, pre Constantin Costache stolnicul (C₃), împreună cu un pașă (C₃), de-l curățîe, cu multe sute de oameni (A), de copaci (P) și de plahii (P). (Ion Neculce, *Letopisețul Țării Moldovei*).

Underlying semantactic structure:

[C₁ ordered C₂ to order C₃ to have S cleared of P by A / to have A remove P from S].

Primăria (C) a apelat la locatari (A) și la firme (A) să curețe zăpada (P) de pe trotuare (S).

*Vitoria (C)... [zise:] – Dă fuga... și adă apă... caută în cuibare vreo două ouă. – Îndată, mămucă, răspunse fata (A). Minodora (A)... cercă ouăle (P) fierte și le (P) scoase din ulcica (S) lor cu o lingură (IT) de lemn într-o strachină (B) cu apă rece (M. Sadoveanu, *Baltagul*).*

*Costache (CAB)... cu ochii plecați în ceașca de cafea, din care (S)... scotea acum drojdia (P) cu degetul (IT) și o mîncă / French: ... retirait le marc avec son doigt, en le léchant (G. Călinescu, *Enigma Otiliei*).*

Unlike the models of case-grammar and of “thematic”-roles, the Romanian actantial model (universal semantax) is not a mere fluctuating list, it is a systemic and structural construction. Moreover, it is closed, stable and exhaustive. Actantial structures are richer than the inventory of θ -roles thanks to two new functions: the Path T (Lm) and the Causer C (Ai).

In order to avoid the current disarray in defining causativity and / or factitivity, our model restricts the category of the Causative to the initial Agent, a role reserved to human actants who plan actional events but instead of accomplishing these themselves, delegate verbally an Executant or Causee to do the job. Thus, natural forces (wind, fire, rain, etc.) and instruments (keys, pens, hands, etc.) are not Causers in spite of involuntarily bringing about some changes in the outside world. Moreover, Causees or Executants, who act prompted / caused by others towards changing the world are not Causers, either. There are three hierarchical levels of factitivity:

⁶ Original Spanish: ... *llegó con su ganado a pasar el río Guadiana, ... no había barca ni barco, ni quien lo pasase a él ni a su ganado de la otra parte... Vio un pescador... le habló y concertó con él que lo pasase a él y a trescientas cabras.*

- [1] initial, causative, directive
 [2] middle, executive, operative
 [3] final, instrumentive, elementary, eventive.

Of course, the first two roles, C (A_i) and A (A_m) can meet in the person of one participant (self-Causer, A_{im}): *Catrina...se apucă și cără nenumărate căldări de apă* (M. Preda, *Moromeții*); *am întâlnit în drum acest orz, ne-am pus și l-am cosit; ce s-a apucat, mă, băiatul tău să povestească în sat că fata mea...?*

Out of the seven actantial roles above, the basic, transitive, three-member sentences select the Executant A and the Patient P as the primary nominal satellites of the Verb.

1.3. Relational syntax

Semantactic structures are configurational (arborescent) and systemic. Syntactic structures are relational and, again, systemic. In a three-member, basic structure, the two nouns can be related to the verb according to four patterns. For instance, the four values of the parameter of case can be displayed systemically in the following rhomboidal table:

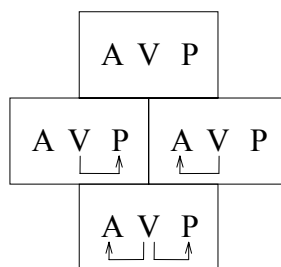

The members of the main opposition are contrasted horizontally. Vertically, there are two neutral relational structures: the upper one is dissociative or exclusive, the lower one is associative or inclusive. The four case structures correspond to the following labels: “nominative – nominative”, “nominative – accusative”, “ergative – nominative”, and “ergative – accusative” (out of which only two were recognized so far).

A given syntactic relation can either be absent, or have a manifest, irrefutable morphological realization on the term that is being dominated. For instance, in the system of case relations, the Nominative is the nude, grammatically insubordinated form of the noun; it bears no visible case morpheme and cannot be said to be «assigned» by the verb.

Relations linking among themselves the Verbal centre of the basic sentence and the two nominals, A and P, can be represented sagittally along three layers:

- [1] the ground-level arrows picture or model the linear sequencing of the three constituents: $N \rightarrow V$ and $V \rightarrow N$

[2] the lower, deep level arrows indicate the semantactic (actantial) relations:

$\begin{array}{c} \text{V} \quad \text{N} \\ \downarrow \quad \uparrow \\ \text{V} \quad \text{N} \end{array}$ corresponds to case (government)

$\begin{array}{c} \text{V} \quad \text{N} \\ \uparrow \quad \downarrow \\ \text{V} \quad \text{N} \end{array}$ corresponds to voice (actantial agreement)

[3] upper, pragmatico-grammatical, sagittal symbols are less deep and signal agreement or concord ($\overline{\text{V}} \quad \overline{\text{N}}$) or a still enigmatic 5th relation ($\overline{\text{V}} \quad \overline{\text{N}}$).

Any given basic (three-member) relational structure can represent the combination of ten relations at the most and can be represented graphically in such an economical, compact and iconic formula as the typograph:

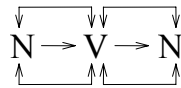

Although natural languages will be found to aggregate in their basic sentences less than ten relations at a time, they do alternate several dozens of relational types, out of a fixed, theoretically determined reserve or general map of 1792 typological variants. For instance, among others, Romanian shows the following seven-relation structure:

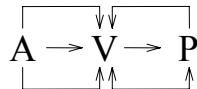

which underlies sentences as *Otilia îl recunosc pe Stănică*.

1.4. Thematization (Topicalization)

The Theme corresponds to the actant chosen by the speaker as the topic (thought of as previously known to the hearer) of the textualized sentence.

| Theme | Rheme |
|-------|-------|
| A | V P |
| P | V A |
| A P | V |
| - | V A P |

The Rheme concentrates the (new) information provided with respect to the (old) Theme. The Verb is the obligatory first Rheme, since it contributes information about the changes continuously and unexpectedly taking place in the referential world.

The distribution of actual languages in the structural types presented in the following pages comes in two series, the first corresponding to the A-Theme sentences, the second to the P-Theme sentences. For instance, the relational system (or parameter) of constituent order types (or values):

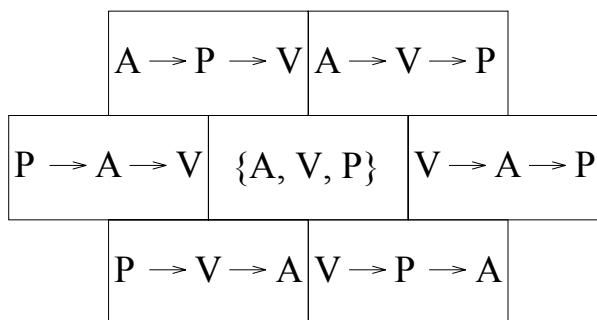

accounts for two series of typological maps,⁷ depending on the alternative thematization of A and P:

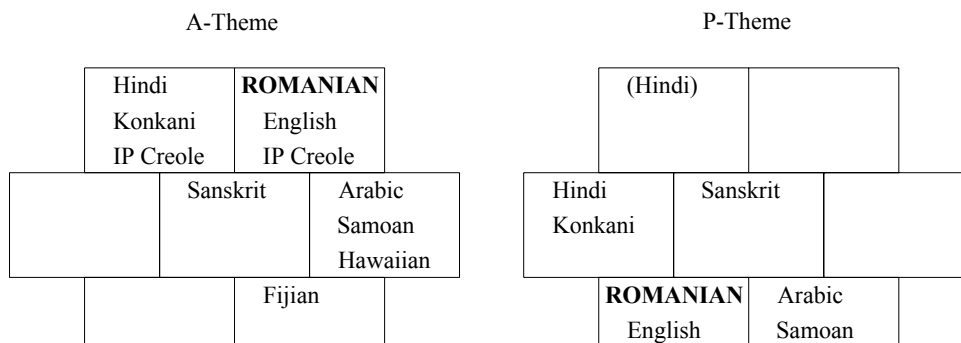

1. Engl. *For God so loved the world* (John, III, 16)
2. Ital. *Dio infatti ha tanto amato il mondo*
3. Port. *Porque Deus amou de tal modo o mundo*
4. French *Car Dieu a tant aimé le monde*
5. Rom. (a) *Căci Dumnezeu așa a iubit lumea*
6. Latin *Sic enim Deus dilexit mundum* (Vulgata)
7. Latin *Sic enim dilexit Deus mundum* (Nestlé Aland)

⁷ These exhaustive maps show that the languages of the world do not cluster together in a single “universal” type-box (or case), and that not all boxes are obligatorily occupied by at least one language.

8. Rom. (b) *Atât de mult a iubit Dumnezeu lumea*
 9. Rom. (c) *Fiindcă așa a iubit Dumnezeu lumea*
 10. Galician *Pois de tal xeito amou Deus o mundo*
 11. Span. *Porque de tal manera amó Dios al mundo*
 12. Hung. *Úgy szeretett Isten a világot*
 13. Ger. *Denn also hat Gott die welt geliebt*
 14. Sanskrit यत इश्वरो जगत्थीथं प्रेम चकार
Yata Íšvaro jagatthītham prema cakāra
 15. Hindi इश्वर ने संसार को इतना प्यार किया
Íšvar ne sāsār ko itnā pyār kiyā (Kamil Bulke)
 16. Hindi क्योंकि इश्वर ने जगत को ऐसा प्रेम रक्खा
kyōki Íšvarne jagatko aisā prem rakkhā
 17. Konkani *Devan sonvsaracho itlo mog kelo*
 18. Marathi देवानें जगावर एवढी प्रीति केली
Devānē jagāvar evadhī prīti kelī
 19. Fijian *Ni sa lomani ira na qai vuravura vakaoqo na Kalou*

Sequential types:

- 1 to 6: $A \rightarrow V \rightarrow P$ 13: $v \rightarrow A \rightarrow P \rightarrow V$ 19: $V \rightarrow P \rightarrow A$
 7 to 12: $V \rightarrow A \rightarrow P$ 14 to 18: $A \rightarrow P \rightarrow V$

This, relational, model of syntactic structures should not be mistaken for the “Relational” Grammar proposed by D. Johnson, D. Perlmutter and others, where, like in all the varieties of Generative Grammar, the term *relation* has in fact come to mean “function” (subject, direct object, indirect object, etc).

2. CONSTITUENT ORDER

The first relational structure that is manifest in the syntactic organisation of basic sentences is the obligatory sequential positioning of the sentence constituents. The three terms of basic sentences, A, P and V, are ordered in different languages in different linear patterns.

Romanian, known as an $A \rightarrow V \rightarrow P$ language, easily shifts to the $V \rightarrow A \rightarrow P$ variant; all other sequences are also met with:

- $A \rightarrow V \rightarrow P$ *Vitoria a primit plosca și a făcut frumoasă urare miresei; vorniceii au întins plosca și-au ridicat pistoalele; Gheorghiiță a pus mâna pe baltă; Felix o iubește pe Otilia.*
 $V \rightarrow A \rightarrow P$ *Trebuie să fi făcut o dihanie cuiabar în hogaș; Înțeleg eu asta; A adus maică-sa tașca; V-a luat vântul ziarul.*

| | |
|-----------|---|
| V → P → A | <i>Înălță frumoasă cântare părintele David; Îi dădea Vitoriei aceste lămuriri un flăcăuș; Aicea ținea crâșmă domnu Iorgu Vasiliu.</i> |
| P → V → A | <i>Povestea asta o spunea uneori Nechifor Lipan la cumetrii; Pe Nechifor l-au răpus răii; Fetița le-a botezat-o protopopul din Baia Mare.</i> |
| P → A → V | <i>Adevărul întreg numai Dumnezeu îl cunoaște; Pe Vasile Baciul râsul îl înfurie; Pe Florica însă George degeaba o iscodise.</i> |
| A → P → V | (the least frequent type) <i>Pasărea mălai visează.</i> |

Some languages allow for two favourite sequential variants, as $A \rightarrow V \rightarrow P$ and $V \rightarrow A \rightarrow P$ in the sample above. Sanskrit displays, besides the neutral $A \rightarrow P \rightarrow V$ sequential structure, the remaining five also, qualifying for the «free order» status, $\{A, V, P\}$. From this Old Indo-Aryan free relational structure, New Indo-Aryan languages (Hindi and Konkani, among many others) have evolved to a petrified $A \rightarrow P \rightarrow V$ type. Under the influence of the Marathi $A \rightarrow P \rightarrow V$ substrate type, the Romance pattern $A \rightarrow V \rightarrow P$ of Indo-Portuguese Creole is steadily shifting to $A \rightarrow P \rightarrow V$. The two sequential types, $A \rightarrow V \rightarrow P$ and $A \rightarrow P \rightarrow V$ alternate freely in the same text: *el tī āndād lāvā korp* (lit. «he had gone wash body»), *pāy fezew ũ tīgā* (lit. «father made a tonga»), as against *el rhekād mandó kasu muler* (lit. «he word sent DAT + his wife»), *pāy rhāpā su kāzmēt fezew* (lit. «father son GEN marriage did»). Speakers of IPCreole are fond of repeating sentences in inverted word order: *el kavó pos, ũ pos kavó* (lit. «he digged hole, a hole digged»), *nigrī ābriw port... port abriw* (lit. «girl opened door ... door opened»). [Field work in the village of Korlai, India, 1973].

In P-Theme sentences, the languages in general change typological cells, as evidenced in the tables above (p. 184). Hindi evinces a strange trend towards keeping the Agent in sentence initial position, despite the verb's being in the passive voice. Fijian loses in passive sentences the rhematized Agent: $V \rightarrow P \rightarrow A$ in the active and $V \rightarrow P$ in the passive. Romanian conforms to the sequential pair $A \rightarrow V \rightarrow P$ and $P \rightarrow V \rightarrow A$ (in the passive); the two sequential types obey to the common pragmatic pattern $\text{THEME} \rightarrow \text{RHEME}_1 \rightarrow \text{RHEME}_2$ (while Fijian opens both types of sentences with RHEME_1 , as opposed to the final- RHEME_1 sequential type of most Indo-Aryan and Dravidian languages.⁸

3. VOICE

Actantial or semantactic agreement of the verb with one of the two nominal constituents of basic sentences A and P is, besides sequential structuring, the main relational consequence of thematization.

⁸. For more details, L. Theban, «Perspectiva liniară a propozițiilor trimembre», SCL, XIX, 1968, 3: 307–315; $A \rightarrow P \rightarrow V$ languages with active voice outnumber, cross-linguistically, the more familiar languages of the $A \rightarrow V \rightarrow P$ type.

Semantactic agreement, or voice, befits the four-member opposition system, in which lower arrows originate in the Nouns that dictate the actantial voice of the verb:

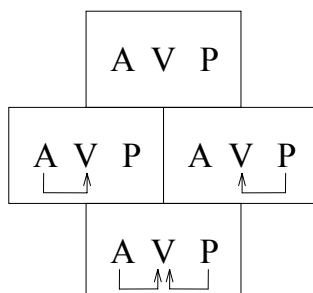

Some languages might be found to lack the opposition of voice, others show the familiar active and passive voice opposition and still others qualify as languages with double or mixed, active-*cum*-passive voice type:

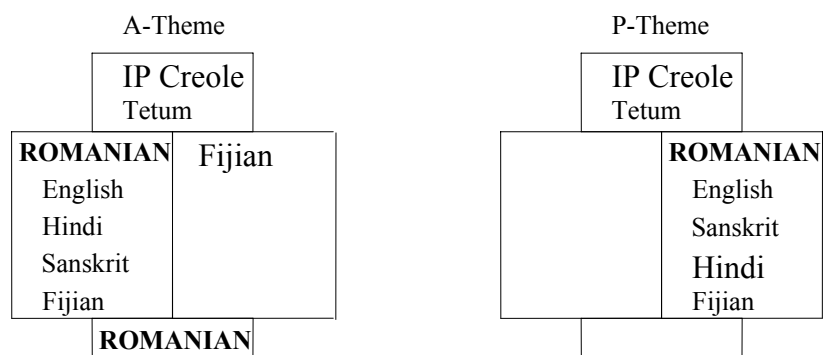

The two voice-neutral languages in our sample do not possess a special verbal form marked to function in P-Thematic sentences. The absence of passive voice marking on verbs disclaims the active (agentive) status of the generally accepted pair. In the collection of Timorese folk tales published in Tetum (by Artur Basílio de Sá, *Textos em Teto da Literatura oral Timorense*, Lisbon, 1961) I did not come across a single passive form of verbs. The only sentence I found which seemed to possess something close to a passive construction, *o nia Maromak ami la hatene* (lit. “you GEN God we not know”) was translated into Portuguese as *O vosso Deus é-nos desconhecido*.

Sentences as *The boy hit the ball* vs. *The ball was hit by the boy*, or Rom. *Țăranii cōsesc fānul* vs. *fānul este cōsit de țărani* illustrate the familiar pairs of active vs. passive voice structures. The passive voice form of the verbal complex

does not rely in all languages on the stative verb “to be”: instead Hindi uses as a passivizer the motion verb *jānā* “to go” after the main verb in the perfective. Sanskrit does not even need a grammaticalized secondary verb to passivize the main verb: the morpheme *-ya-*, deprived of independent lexical meaning, is infixed in the “*ātmanepada*” (“middle”; the result of the action accrues to A) form of the verb, constructed with a thematized P: *pacati* “A cooks / is cooking” vs. *pacyate* “P is cooked / is being cooked”. In Fijian the passivizer is a postfixed morpheme, *-i*, which replaces the active voice ending *-a*: *sa raica* “A sees” vs. *sa raici* “P is (being) seen”.

An interesting phenomenon is observed in Fijian: in A-Theme sentences with certain [+human] Patients, the Verb is put in the passive voice (V-i), yielding, thus

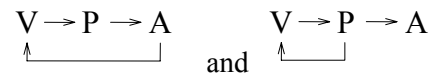

(*sa raica na waqa na yalewa*, lit. “sees the boat the woman” vs. *sa raici Timoci na yalewa* “the woman sees Timothy” vs. *sa raici na waqa / ko Timoci* “the boat / Timothy is seen”).

An equally fascinating typological peculiarity is found in Romanian in sentences with [+human] Patients: the verb phrase in the active voice receives an additional, passivizing morpheme, a phenomenon known as clitic doubling on verbs. The oblique, accusative pronominal morphemes *îl, o, îi, le* grant the entire verbal construction a double, mixed voice format.

Pascalopol o iubeste pe Otilia (Pascalopol her + loves ACC Otilia)

Stănică l-a adus pe doctorul Vasiliad (Stănică him + has brought ACC dr. Vasiliad)

The important novelty about the voice relational structure in Romanian is the presence of the associative, double voice, agentive-cum-patientive, confirmed additionally by the double concordial relation:

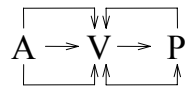

In Romanian, as in Fijian, the passive marking of verbs in otherwise active syntactic frames reflects the promotion of remarkable Patients to higher pragmatic status. In Romanian, the advancement of P to the left of V automatically triggers the (additional) passivization of the active voice verb.

Ion... în genunchi a rugat pe Herdelea să scrie jalba (L. Rebreanu, *Ion*)

Laura urăște pe Pinte (*Ion*; in V → P sentences, Rebreanu carefully avoids clitic doubling)

Pe Laura scrisoarea a uimit-o atât de cumplit... (*Ion*)

Jumătate delnița mi-ai furat-o, tâlharule! (*Ion*)

Pronominal oblique morphemes are normal markers of the voice relation just as auxiliary verbs or lexically meaningless affixes are; see the use of the reflexive pronouns with verbs whose nominal subject designates a participant involved in the event with both actantial roles, A and P (*Ion se duce la Armadia*; [AP] *s-a urcat în pod*; [AP] *s-a aruncat / s-a înecat în Mureș*). Thus $\begin{array}{c} A \rightarrow V \rightarrow P \\ \underbrace{\quad \uparrow \quad} \end{array}$ is comparable to $\begin{array}{c} [AP] \rightarrow V \\ \underbrace{\quad \uparrow} \end{array}$ in subordinating the voice of the verb phrase to A and, additionally, to P.

4. CASE

Case is the reverse of voice: both relations serve to give a syntactic expression to the semantactic, actantial deep organisation of the events being described by basic sentences.

The nude, dictionary form of a noun or of a pronoun is external and immune to case government. Confronted to a Noun in the nominative, the verb is relationally powerless; the Verb is only capable to assign oblique cases. A Noun taken *tel quel* from the dictionary has and keeps automatically the acasal, absolutive form, which cannot, then, be said to have been assigned by the verb. There is no infirmity in some language leaving nouns in the rhematic segment in the nominative, as in *the boy hit the ball*, *băiatul a lovit mingea* (both $A \rightarrow V \rightarrow P$), or in *Jack hit Jill*. The sentences above have both nouns in the nominative, as against Rom. *Jack a lovit-o pe Jill*, where the human Patient is put in the Accusative (Patientive) case, or Hindi राम ने रावण को मारा *Rām ne Ravaṇ ko mārā* «Rām killed Ravaṇ» where no Nominative is preserved (the thematic A is in the ergative case, the rhematic P is in the accusative case).

Typology compels us to be faithful to syntactic realities and as precise as possible, in order to insightfully compare languages. In the intimacy of a single language we are free to interpret mother tongue facts as we like (or find convenient, for pedagogical purposes); but once we place the same language in a multilingual, typological frame, theoretical interpretations have to become straight, true to the specificity of every language present in the sample. Simone de Beauvoir respected the A V P pattern when writing *personne en France n'approuve les Américains* (*Les Belles Images*, 1956), while Ileana Vulpescu conforms to the

$\begin{array}{c} A \ V \ P \\ \underbrace{\quad \uparrow} \end{array}$ structure when translating *nimeni, în Franța, nu-i aprobă pe americani* (*Imagini frumoase*, 2004). In the reverse translational direction, the sentences ... *și Otilia recunosc pe Stănică. – Ce faci aici? Unde ai lăsat-o pe Olimpia?* (George Călinescu, *Enigma Otiliei*) were rendered as ... *et Otilia reconnut Stănică. – Qu'est-ce que tu fais là? Où as-tu laissé Olimpia?*. Again, in sentences like A

recunosc drumul and *A a lăsat cărțile acasă*, the syntax is identical with that of French, viz. A V P, «nominative – nominative». Nominative Patients and Accusative Patients may be coordinated within the same sentence: *Angajații spitalului au agresat trei ziaristi și pe directorul DSP Dolj (Gândul); Sergiu...bineînțeleș nu prinde termenul congresului, dar vede Parisul și pe Mircea Eliade* (Dorina Al-George, *Șocul amintirilor*). Nominatives (Absolutives) are ungovernable. Facts are plain and simple, both interlingually and intralingually, when they are based solely on morphological proofs.

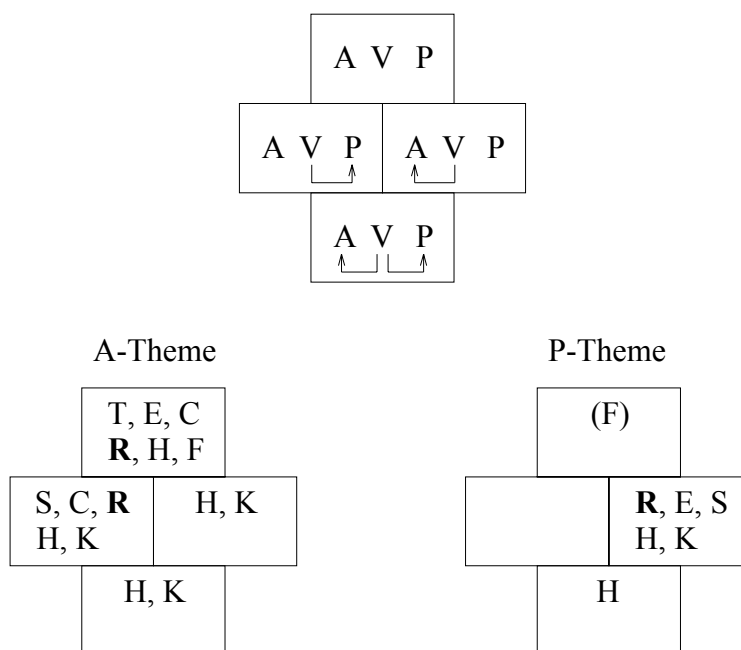

5. AGREEMENT

Agreement is the only syntactic relation in which the link between the thematized actant and the verb admits a scale of tightness, according to the number of formal differences within the paradigm of a given tense / aspect. In English past tense sentences there is no concord at all, like in Chinese, Japanese or Indo-Portuguese Creole: (*I / you / the boys / the boy hit the ball*); in other tense paradigms, the number of contrasting terms is limited to two (*the boy hits* vs. *the boys hit*). The agreement link is tighter in Romanian (5 differences: *vorbeșc*, *vorbești*, *vorbește*, *vorbim*, *vorbiți*), in Portuguese (6) and in Sanskrit (9, thanks to the dual series).

Tetum is remarkable on two accounts: its verbs do not agree with nouns and pronouns, in the standard variant, but in its Contracosta dialect, the verbs do agree with thematized A. The concordial morphemes in this dialect are not centrifugal (postposed) but centripetal (preposed to V): *karé* (I see), *maré*, *naré*, *haré*, *raré*.

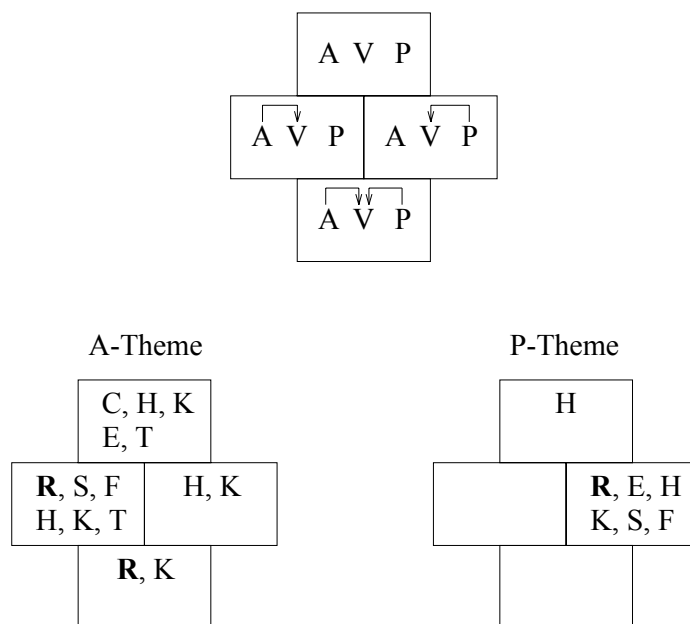

6. THE 5-TH RELATION

The sagittal model of relational syntax allows for one more graphical space, awaiting empirical confirmation. On the other hand, live sentences contain syntactic phenomena which cannot be fitted in any of the four relational parameters examined so far.

All that is left after examining the four syntactic relations (w.o., voice, case and agreement) will be relegated to a fifth relational dimension, where the upper arrow, originating in the Verb, points to A or to P, or to both. One face of this fifth relational type is the agreement of a nominal constituent with V, in some purely verbal category.

For instance, in Hindi, A gets an ergative postposition every time the transitive verbal constituent is in the perfective aspect; this case postposition, *ne*, signals not only that the nominal so marked is an A, but also announces that the verb coming at the end of the sentence is perfective. So, the Noun agrees with the Verb in aspect.

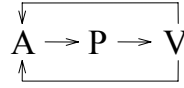

Another, equally interesting instance of the relation $V \ P$ represents a pragmatic reorganisation of the semantactic, actantial structures. In Sanskrit, actants other than P get a secondary, pragmatic accusative case besides the semantically motivated accusative of P:

बालो वापीं गजाननयत

bālo vāpīm gajānanayat

«the boy led the elephants to the pond»

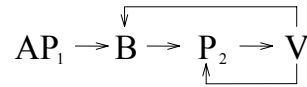

रामोऽश्वेभ्यो गजान गच्छति

rāmo 'śvebhyo gajān gacchati

«Rāma goes from the horses to the elephants»

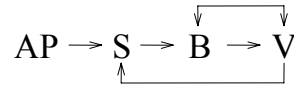

The accusativized noun *gajān* is a Patient in the first sentence and a Beneficiary (final Locative) in the second.

In Romanian, the Rhematic P can preserve its Nominative case form in the immediate vicinity of V:

Țăranii au încărcat cocenii în căruța («the farmers loaded the maize onto the cart»)

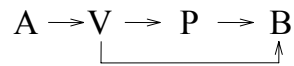

Colonelul și-a șters nădușeala de pe chipiu

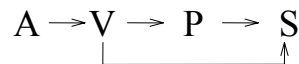

In case the speaker wishes to give B or S a more prominent status and advances the respective noun from the TH₃ to the TH₂ position, the fifth relation intervenes and effaces, by nominativization, the locative marking, while P is marginalized to the TH₃ position and gets an overt pragmatic case, the preposition *cu* («with») when preceded by B, or *de* («of / from») when preceded by S:

Țăranii au încărcat căruța cu coceni

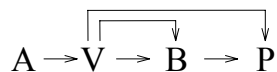

Colonelul și-a șters chipiul de nădușeală

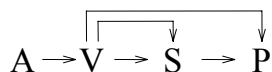

In the two situations above, the Nominative is marked, insofar as it contrasts with and replaces the basic locative markers of B and S. The preposition *cu* corresponds, in other languages, to markers with different semantactic meanings:

Atunci ce să fac cu cel pe care îl numiți regele iudeilor ? (Mark, XV, 12)

E. *Then what shall I do with the man ?*

Galician *E que fago eu con esse?*

Span. *Que haga del que...?*

French *Que ferai-je de celui...?*

Port. *Que...faça d'Aquele...?*

Ital. *che cosa...faccia di colui...?*

Lat. *Quid...faciam regi...?* (dative)

Fijian *a cava...me'u kitaka yua ?* (dative)

Konkani... *patxaiak hanvem kitem kelelem?* (dative / accusative)

Hindi मैं इस मनुष्य का क्या करूं ... ?

māi is manuṣya kā kyā karū? (genitive)

Marathi त्यचें मीं काय करावें

tyacē mī kāy karāvē? (genitive)

Sanskrit यम...राजानं...तं प्रति...मया कर्त्तव्यं ... ?

yam...rājānam...tam prati...mayā krirtavyam...? (accusative +

locative)

The 5-th relation is the least studied and understood aspect of syntactic structures; without it, the basic, three-member structures have 448 quadri-relational typological variants to choose from and to materialize in sentence outputs.

7. CONCLUSIONS

Two extreme stands are currently upheld in the issue of Typological *versus* Universal Grammars: [1] there is no end to the diversity of grammatical systems and structures and, on the contrary, [2] grammars of all languages conform to a single, narrow straitjacket. Romanian typological syntax has taken the middle, realistic path and claims that the structural variability of *relational* syntactic structures is impressive indeed but accessible and amenable to precise mappings, like the tables of sagittal typographs wherein we have been able to situate multicontrastively the typological identity of Romanian. For the three-member

basic sentences above, the combination of the (four to seven) values of the five relational parameters yields as many as 1792 different syntactic structures; one or two hundred of these may be shown to exist or are awaiting discovery. The theory of (relational) syntax has firm and ample grounds to keep building abstract models and programs. In Functional Syntax things are much simpler: all languages have previously fabricated Subjects, Direct Objects, Indirect Objects, etc., so there remains nothing to typologize and syntax is plainly and forcibly universal.

The main source of innovating ideas in syntactic theory is the richness of relational types underlying the languages of the world. However impressive might prove this diversity, linguistic typology is prepared to embrace, systematize and articulate in precise new representations the entire set of syntactic types of natural languages, (and, should the necessity arise, of artificial languages too).

Syntactic types are neither lost in an ocean of unknown expanse and shape, nor compressed forcibly in a single, «universal» mould. The typological maps proposed in this paper delimit with precision the contours of theoretically imaginable syntactic variability, and facilitate in a rapid overview the identification of the syntactic types peculiar to Romanian (some of them newly brought to light and too original to be accepted by all from the outset). Finally, it is instructive to visualize in tabular cartographic form the five relational parameters, and see with which languages Romanian syntax shares typological resemblances, which other languages are dissimilar, and how, and to make known what zones of the typological maps remain unpopulated.

The syntactic type of a natural language, say Romanian, can be contemplated and defined [1] from within, [2] from without but from a short distance (related or neighbouring languages) and [3] from without and from afar (the ideal basis for theoretical grammar). Not only the typological organisation of exotic languages can be an object of wonder for the theoretical typologist and for a specialist of Romanian grammar: seen in the reverse direction, from such distant vantage points⁹ as Hindi, Sanskrit, Konkani, Indo-Portuguese Creole, Fijian or Tetum, the typological specificity of Romanian Syntax reveals itself as unexpectedly exotic and theoretically insightful.

Romanian grammar will greatly benefit from its being subjected to a typological description, in a multilingual framework; conversely, typological linguistics will advance and broaden its basis if assisted by the newly discovered structures specific to the Romanian relational syntax.

⁹ Such a suggestion in favor of an EXTERNAL TYPOLOGY was made in Maria Theban, Laurențiu Theban, "Pour une typologie externe de la grammaire des langues romanes", RRL, XXXIII, 1983, 3: 277–288.